

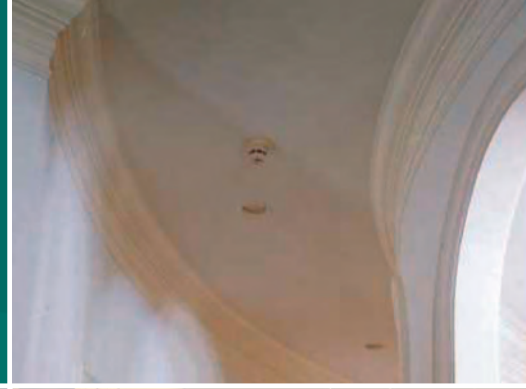

RESINART Corp.



Flexible Mouldings
Catalog



DURAFLEX™

THE ORIGINAL FLEXIBLE MOULDING

Duraflex™ – The Original Flexible Moulding since 1967 is an exclusive product of ResinArt. This catalog illustrates many popular styles of moulding, but these are only a portion of the 8,000 patterns we offer.

Check the Table of Contents for a category of mouldings. Locate and match your actual wood moulding to the illustrated full scale drawing.

When ordering please specify the part number, length – (lineal feet) and surface; smooth finish, oak or pine texture. Duraflex™ is the easy economical alternative for radius installations and because of its quality, flexibility and superior longevity it is unequaled by wooden millwork.

The Advantages of Duraflex:

- The appearance of real wood.
- Ease of installation using standard woodworking equipment - cut, sand, shape, and finish like wood.
- Seamless construction without lamination defects.
- Painting: Primer coats are unnecessary. Most standard paints are compatible.
- Staining: Use a heavily pigmented stain and finish with a clear coat.
- Can accommodate VIRTUALLY ANY RADIUS WHICH IS 3 TIMES A PROFILE WIDTH OR GREATER.
- Moisture proof. Insect proof.
- Duraflex is recommended for profiles 6" or wider due to a 0% shrinkage factor.

If you don't find the moulding that you are looking for ResinArt can produce custom moulding from your wooden original. We can also work from tracing - (paper pattern) for any arch, circular window, curved wall or curved frame.

TABLE OF CONTENTS

Order Form	ii
General Product Information and Guidelines	iii
Templates Required	iv
Flexible Limitations & Ranges of Movement	v
Worksheet	vi
Crown	1-22
Base	23-49
Casing	50-70
Panel, Cove, Half Round, S/4/S & Miscellaneous	71-84
Chair Rail	85-87
General Conditions	Inside Back Cover

RESINART CORPORATION INC.

"Flexible Trim Moldings" 1621 Placentia Ave Costa Mesa CA. (949) 642-3665 Fax (949) 642-6519 www.resinart.com

ORDER FORM

Date: _____
 Company: _____

P.O. # _____
 Ship To: _____

Radius Half Circle Window & Door Casing

All Casing is made with thick edge to outside unless specified

Part No.	Quantity	Length	Radius	Dura Flex	Xtra Flex

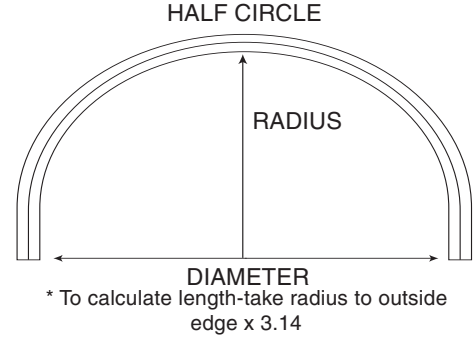

Arched Window & Door Casings

Part No.	Quantity	Length	Height (Rise)	Width	Dura Flex	Xtra Flex

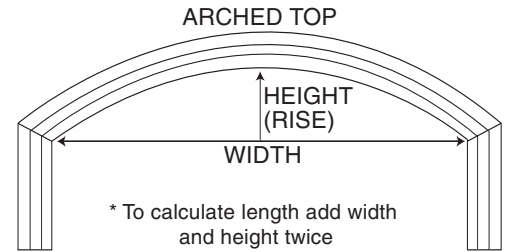

Elliptical or Oval (Template must be provided) Please # if more than one	Part No.	Qty.	Template #	Dura Flex	Xtra Flex

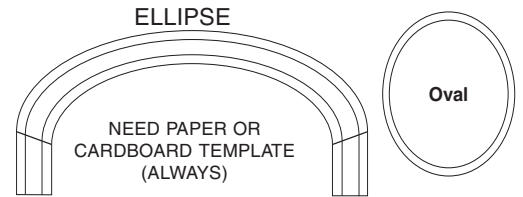

Crown & Cornice

Part No.	Quantity	Length	Radius	Concave (ISR)	Convex (OSR)
				Check <input checked="" type="checkbox"/> ()	()
				OSR ()	()
				or ()	()
				ISR ()	()
				()	()
				()	()

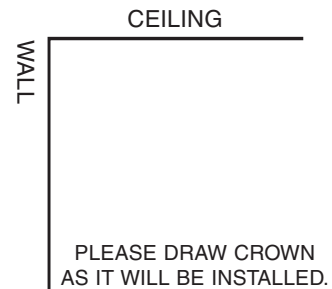

Straight Parts

Part No.	Quantity	Length	Dura Flex	

IMPORTANT NOTES
* Note: Smallest radius that can be made is 3 times the width of any Profile.
* Note: Jamb stock flex, order as straights



GENERAL PRODUCT INFORMATION AND GUIDELINES

PAINTING

Painting can be done with all paints such as Latex, Enamel, Waterbase and Oils. Best results are seen when a primer coat is applied. When using Alkyd Enamels or Oil based enamels a waterbase or Latex undercoat is required. Alkyd Enamels and Oil based enamels may not dry properly if an undercoat is not used. Waterbase enamel can be used as a primer.

STAINING

Staining is achieved with glazes. Some colored glazes are prepackaged by manufacturers for this purpose. Clear glazing liquid mixed with tints and stains is another option to customize colors. A simpler solution is "GEL" stains made by ZAR, MINWAX, and WOOD-KOTE. These are designed to work on synthetic surfaces. Clear coats must be applied after staining. To achieve certain shades and colors, a base color coat may need to be applied before glazing. Base color coats as RED-BEIGE, or MUSTARD YELLOW or MED. BROWN have major effects on over-all look after glaze is applied.

HOW TO ORDER BUILD UP DETAILS

Understanding what Radius information is needed and which details will be made straight:

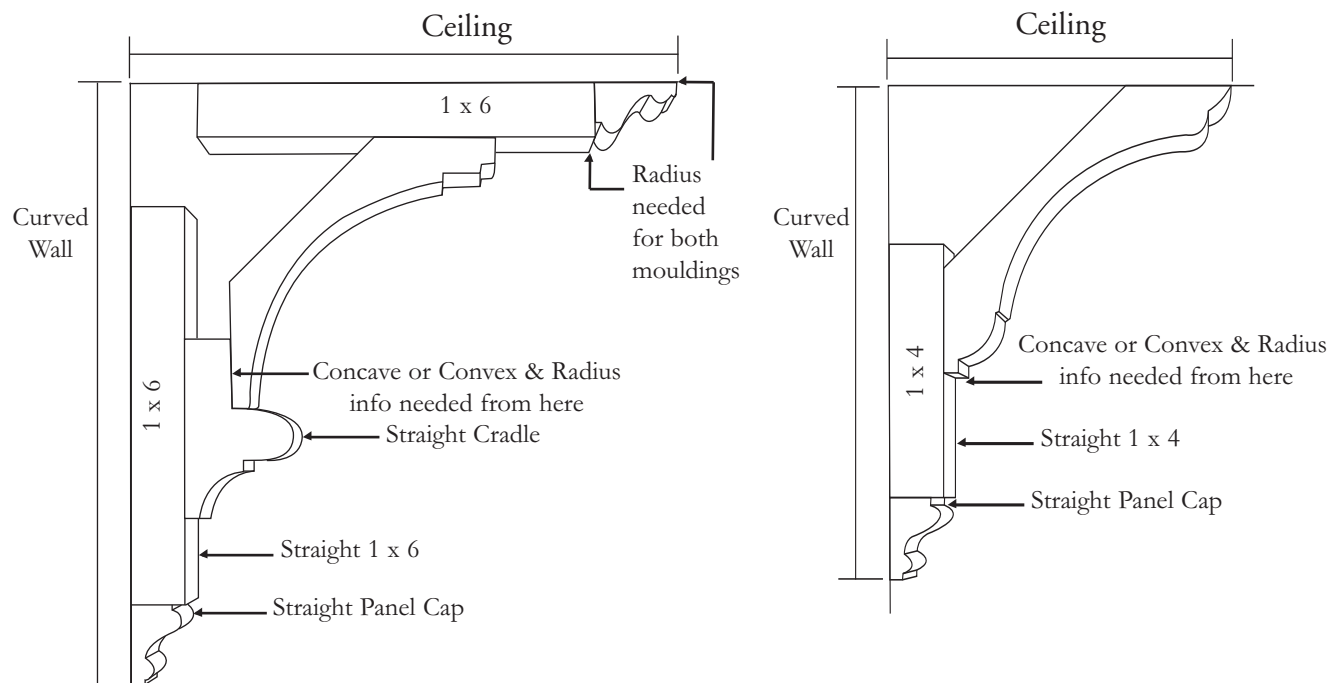

TEMPLATES REQUIRED FOR OVALS, ELLIPTICAL, & IRREGULAR RADIUS CROWN

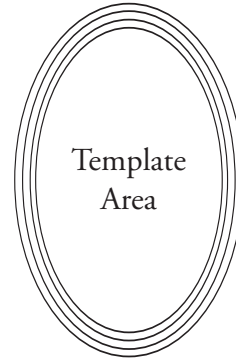
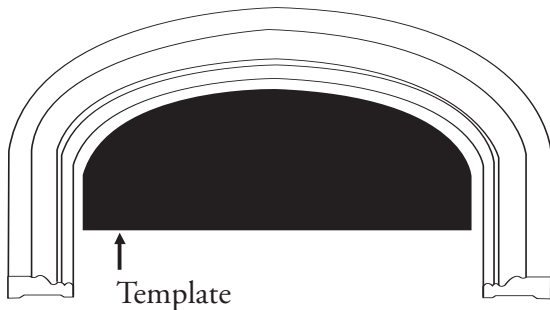

RADIUS CROWN AND DORMER APPLICATIONS

What we need to know:

- Supply radius dimension of wall or radius to outside edge of Dormer.
- Any curved segment dimension should be converted to a radius.
- ISR (Inside Radius) wall curves away from you.
- OSR (Outside Radius) wall curves toward you.
- Dormer application is always an OSR.
- Profile or description confirming crown orientation on wall (i.e., position on wall)
- Calculate length needed and add extra footage for waste, to trim and install.

Convex
Curves "Outward" O.S.R.

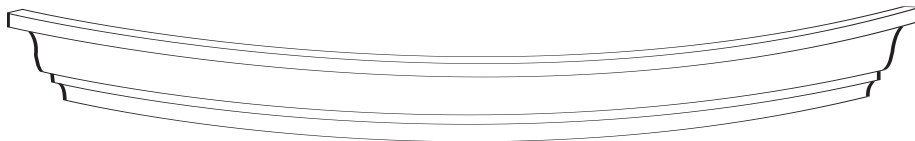

Example of orientation

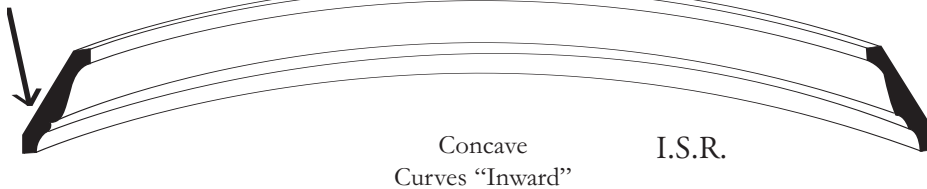

Concave
Curves "Inward" I.S.R.

FLEXIBLE LIMITATIONS & RANGES OF MOVEMENT

STRAIGHT BASE OR CASING BENDING AGAINST THICKNESS

Applications bending against the smaller dimension usually the 1/2" - 1-1/2" thick (i.e. Base with measurements 5/8 x 4-1/2) will bend easily in the direction of the lesser dimension with no pre-curving necessary.

Minimum radius 10".

Product has a tendency to cup when bent too tight on wall.

Moulding will not bend around 3/4" or 1-1/2" bullnose corners.

STRAIGHT CROWN

NOT ADVISABLE. Customer should supply radius information to allow Resinart to confirm if straight will work.

MEASURING

Calculate approximate lengths needed using radius B in inches and round up to nearest foot. Use Radius A and Width A dimension for ordering actual part.

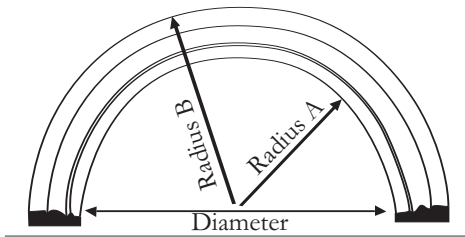

Radius B (x) 3.14 (÷) 12 = minimum length needed

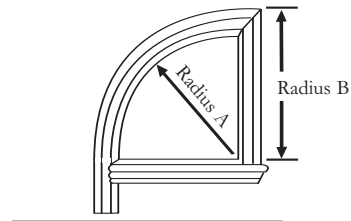

Radius B (x) 3.14 (÷) 2 (÷) 12 = minimum length needed

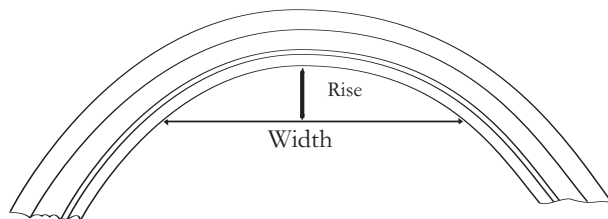

Rise (x) 2 (+) Width = minimum length needed

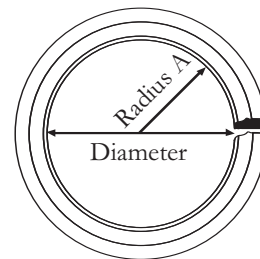

Diameter (x) 3.14 (÷) 12 = minimum length needed

WORKSHEET



CROWN

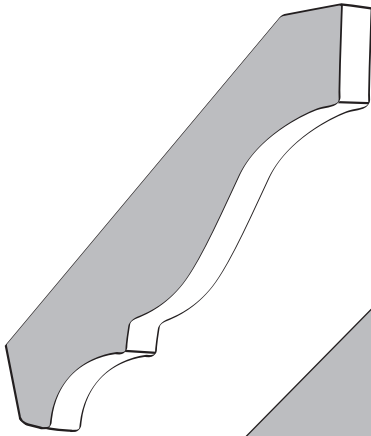

C-WM52
8010
D-LS52
 $\frac{9}{16} \times 2\frac{3}{4}$

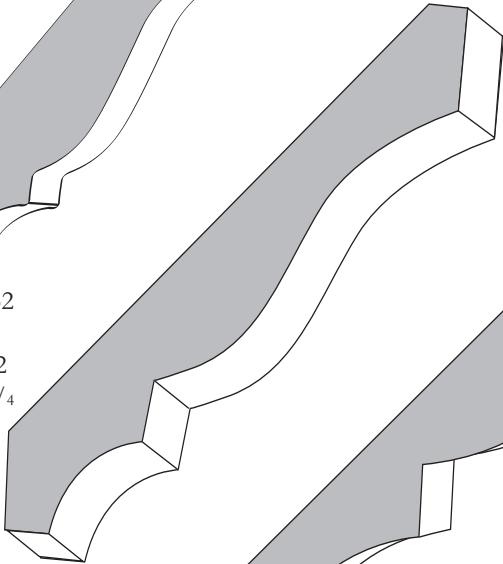

C-TX49
D-8009
 $\frac{9}{16} \times 3\frac{5}{8}$

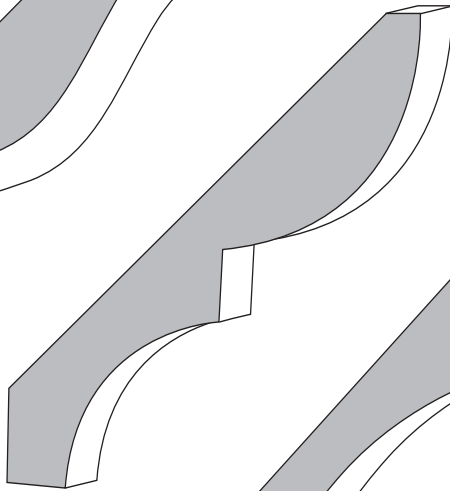

D 8020
 $\frac{9}{16} \times 3\frac{1}{4}$

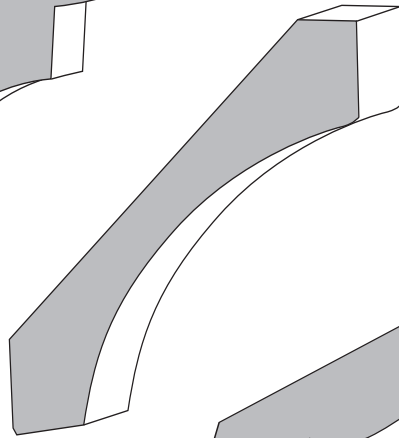

D 8026
 $\frac{9}{16} \times 2\frac{3}{4}$

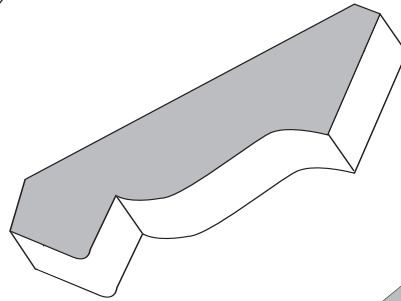

D-8008
 $\frac{9}{16} \times 2\frac{1}{4}$

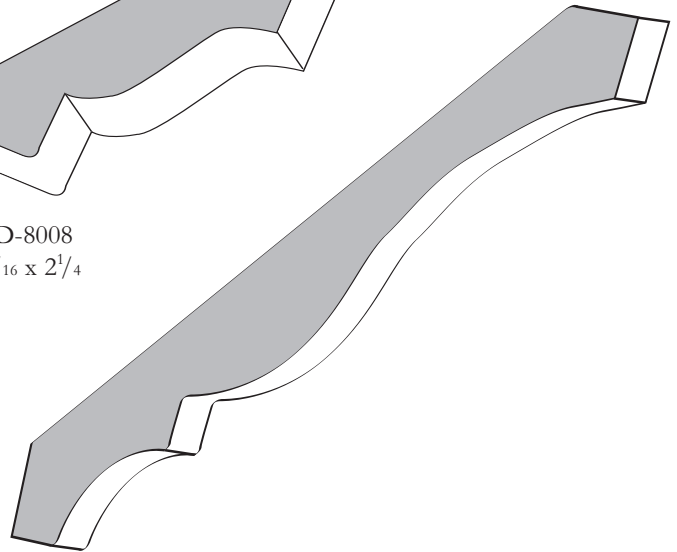

D8012
D-L548
 $\frac{9}{16} \times 4\frac{1}{4}$



CROWN

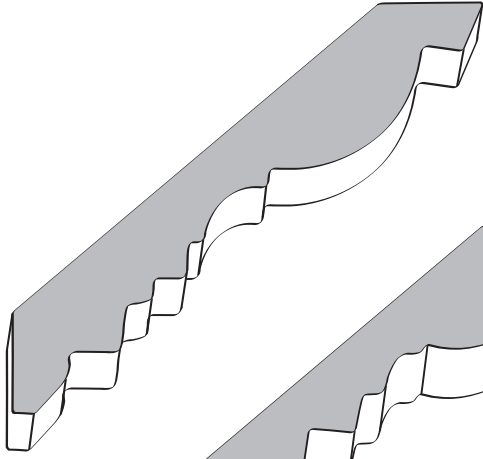

DW 20
 $\frac{9}{16} \times 3\frac{1}{4}$

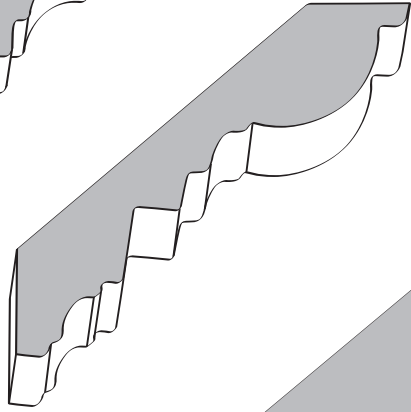

DW 21
 $\frac{9}{16} \times 2\frac{3}{4}$

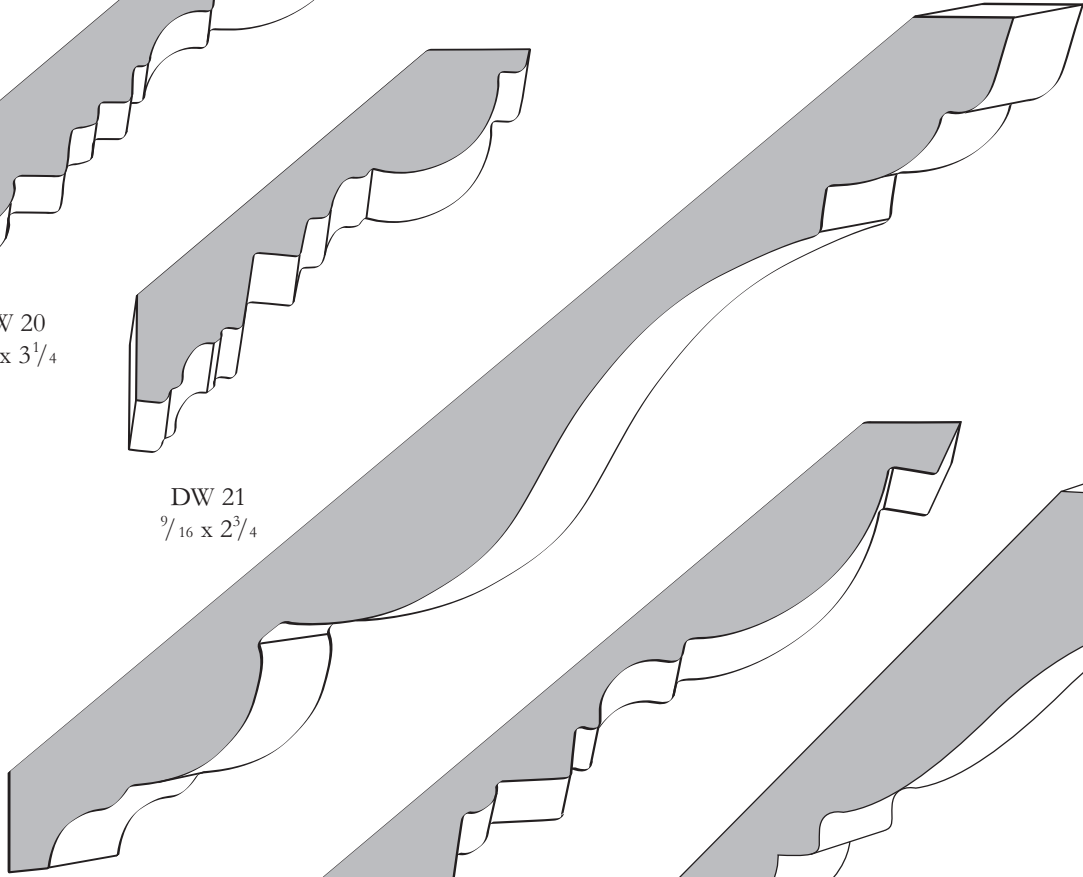

DW 48
 $\frac{11}{16} \times 6\frac{7}{8}$

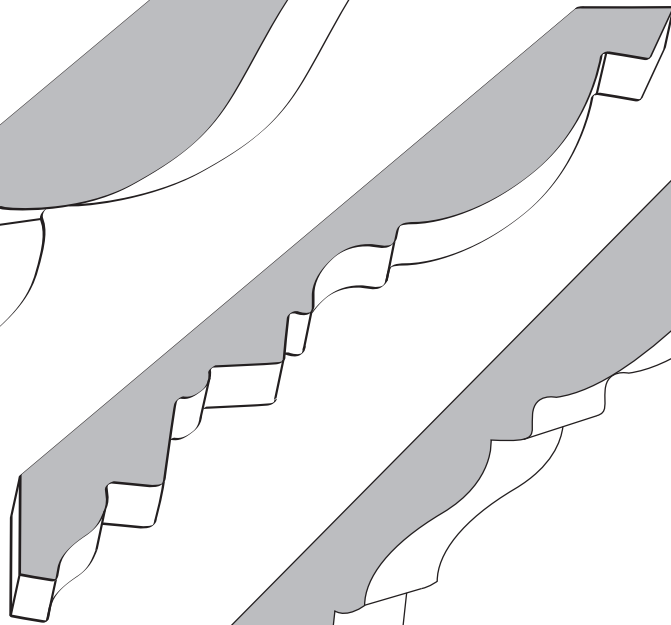

DW 22
 $\frac{9}{16} \times 4\frac{1}{2}$

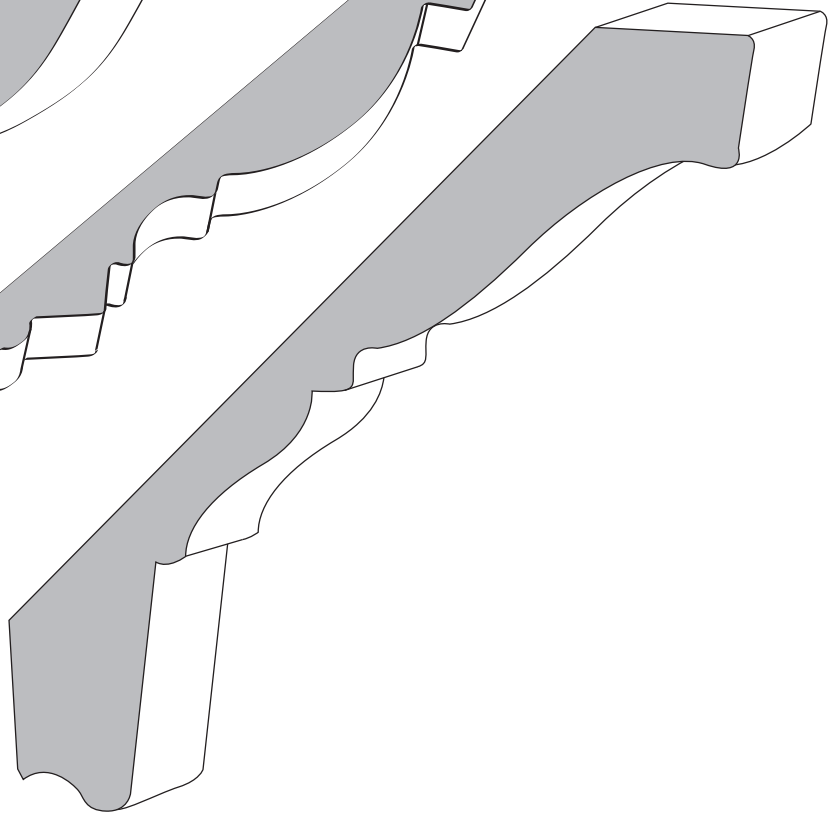

DW 40
 $1\frac{1}{4} \times 5\frac{5}{8}$



CROWN

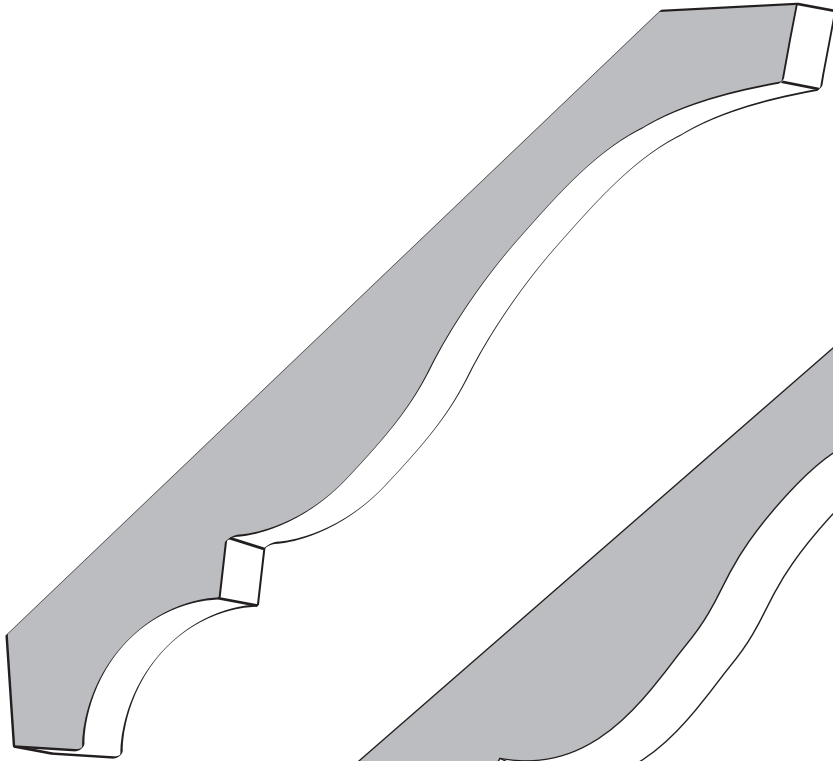

DW 58
 $1\frac{11}{16} \times 5\frac{5}{8}$

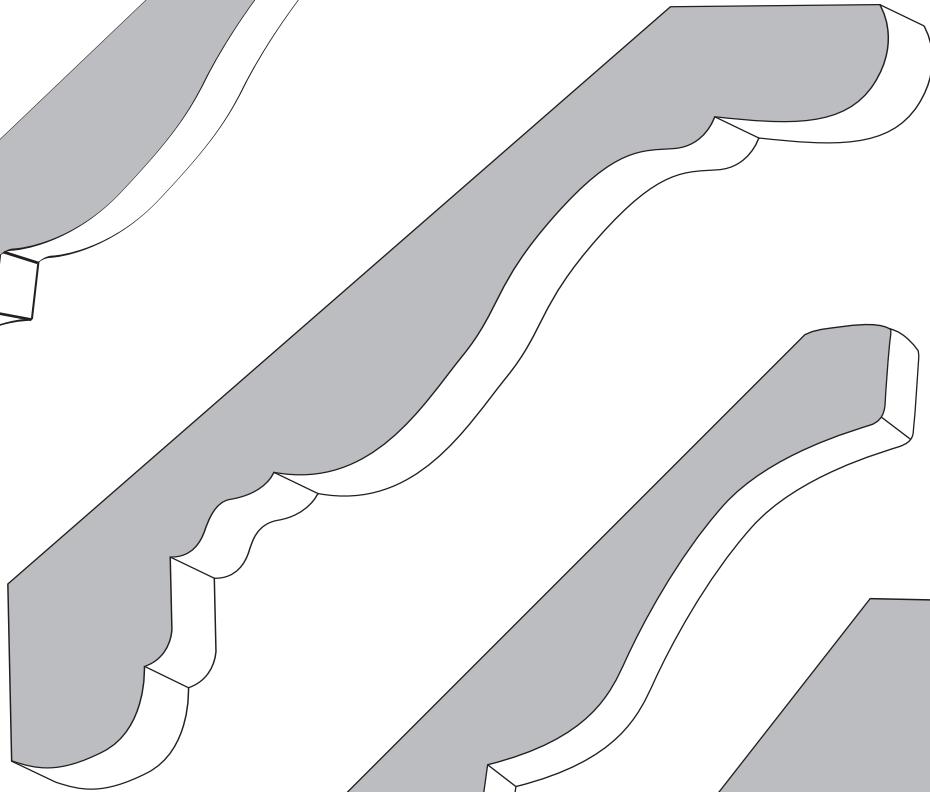

EL408-U
 $1\frac{1}{16} \times 6$

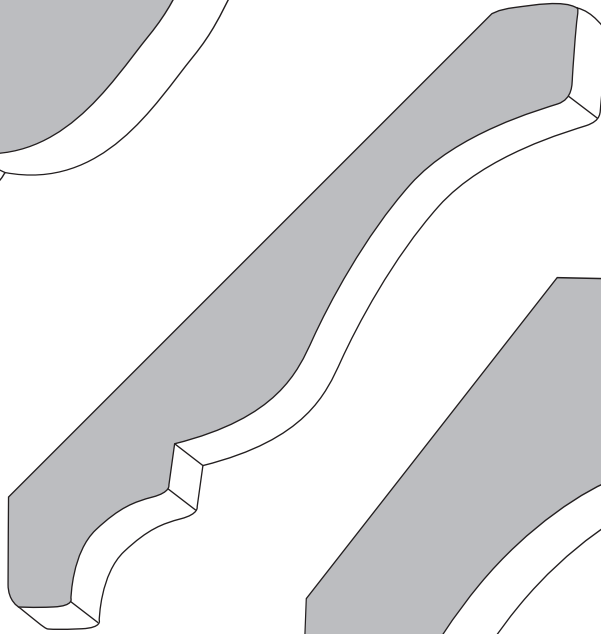

EL406-U
 $\frac{9}{16} \times 4\frac{1}{4}$

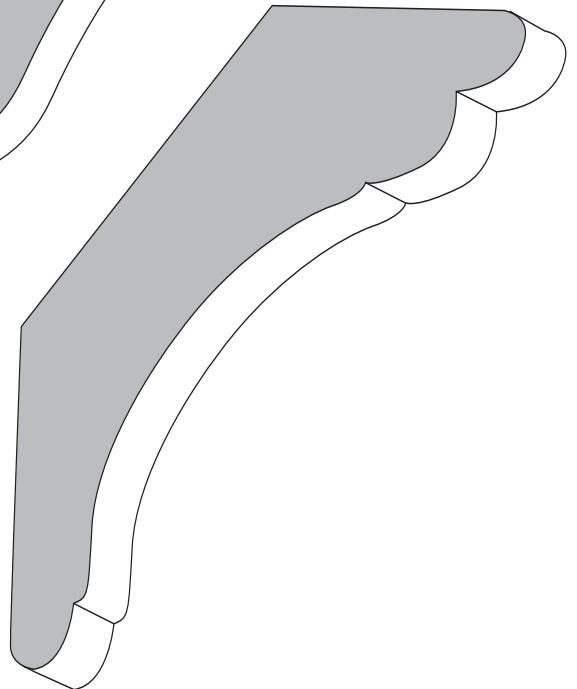

EL407-U
 $1\frac{1}{8} \times 4\frac{1}{4}$

CROWN

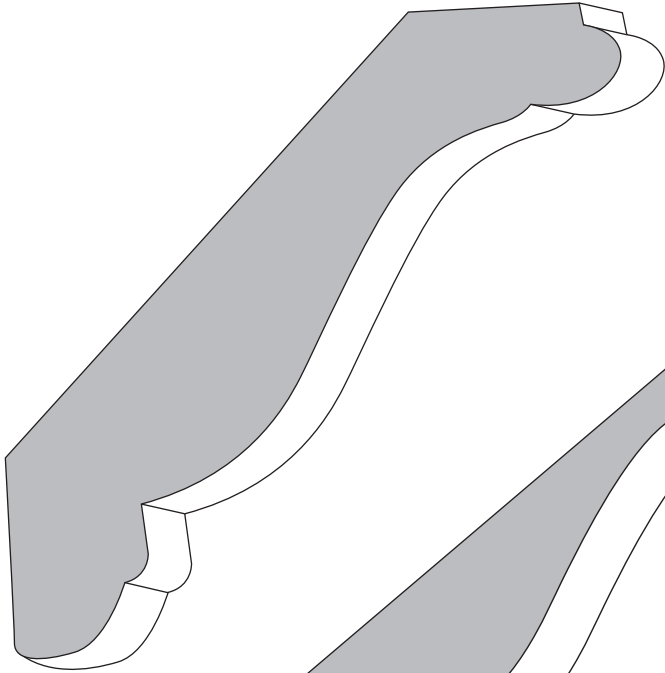

EL409-U
 $\frac{3}{4} \times 4\frac{1}{2}$

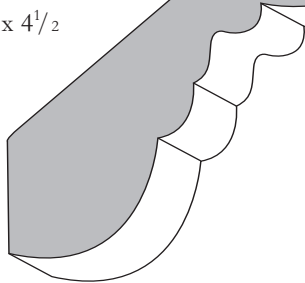

EL410-U
 $1\frac{1}{16} \times 5\frac{7}{8}$

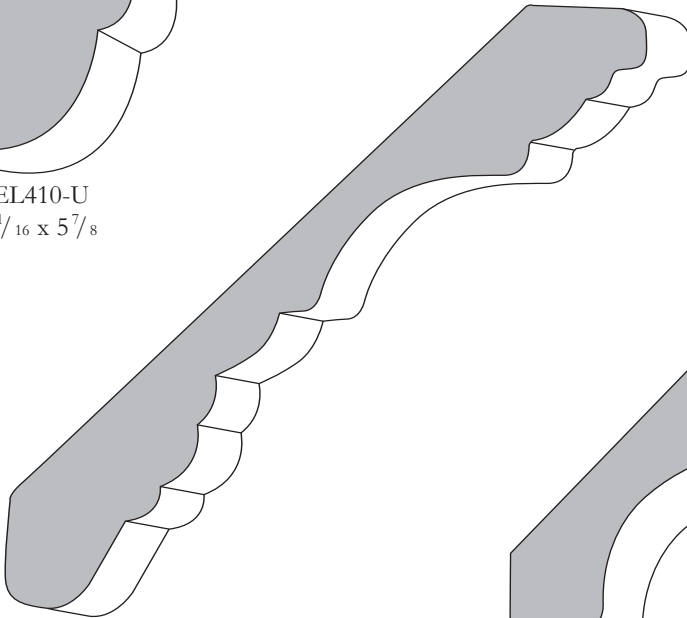

EL412-U
 $\frac{9}{16} \times 4\frac{1}{2}$



EL413-U
 $\frac{9}{16} \times 4\frac{1}{4}$

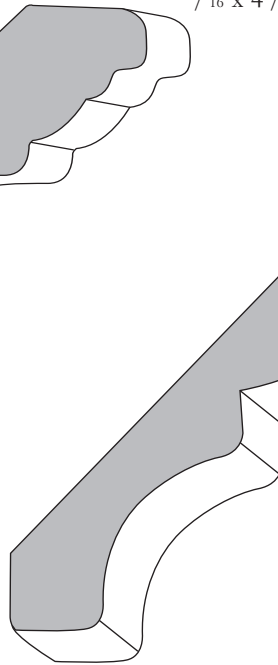

EL414-U
 $\frac{9}{16} \times 5\frac{1}{4}$

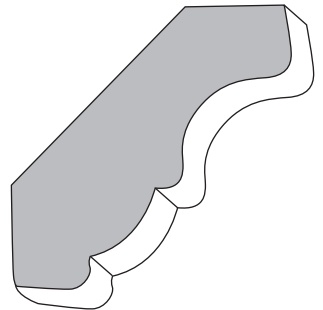
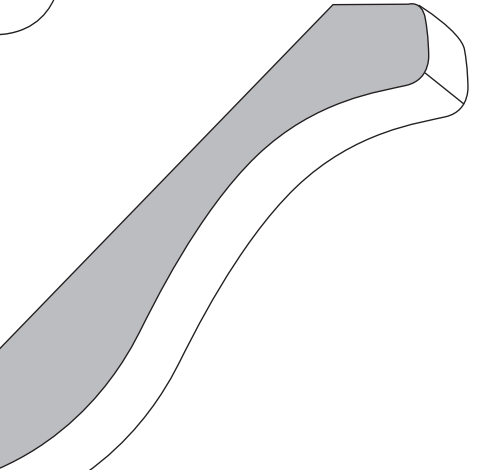

EL420-U
 $\frac{9}{16} \times 1\frac{7}{8}$



CROWN

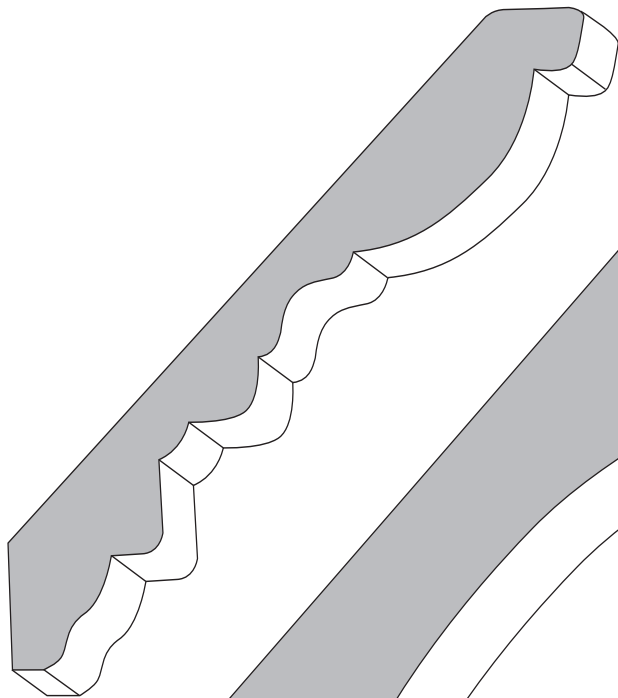

EL422-U
 $\frac{9}{16} \times 4\frac{1}{2}$

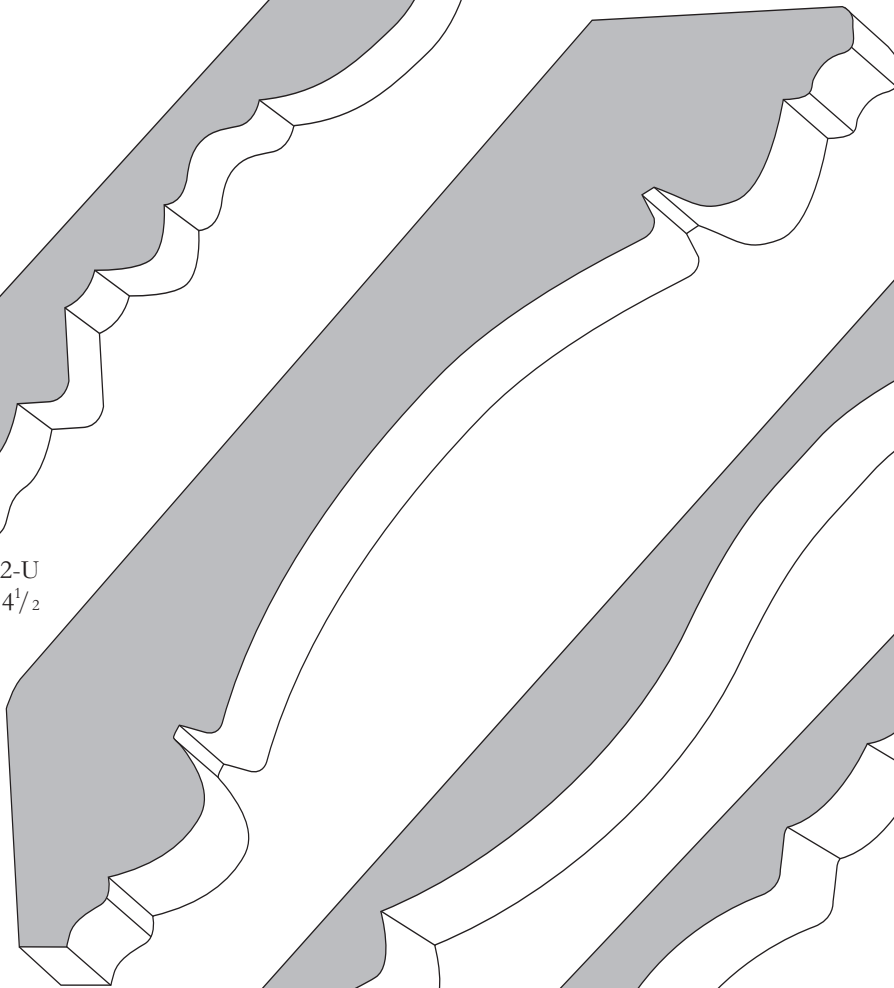

EL424-U
 $1\frac{1}{8} \times 6\frac{1}{2}$

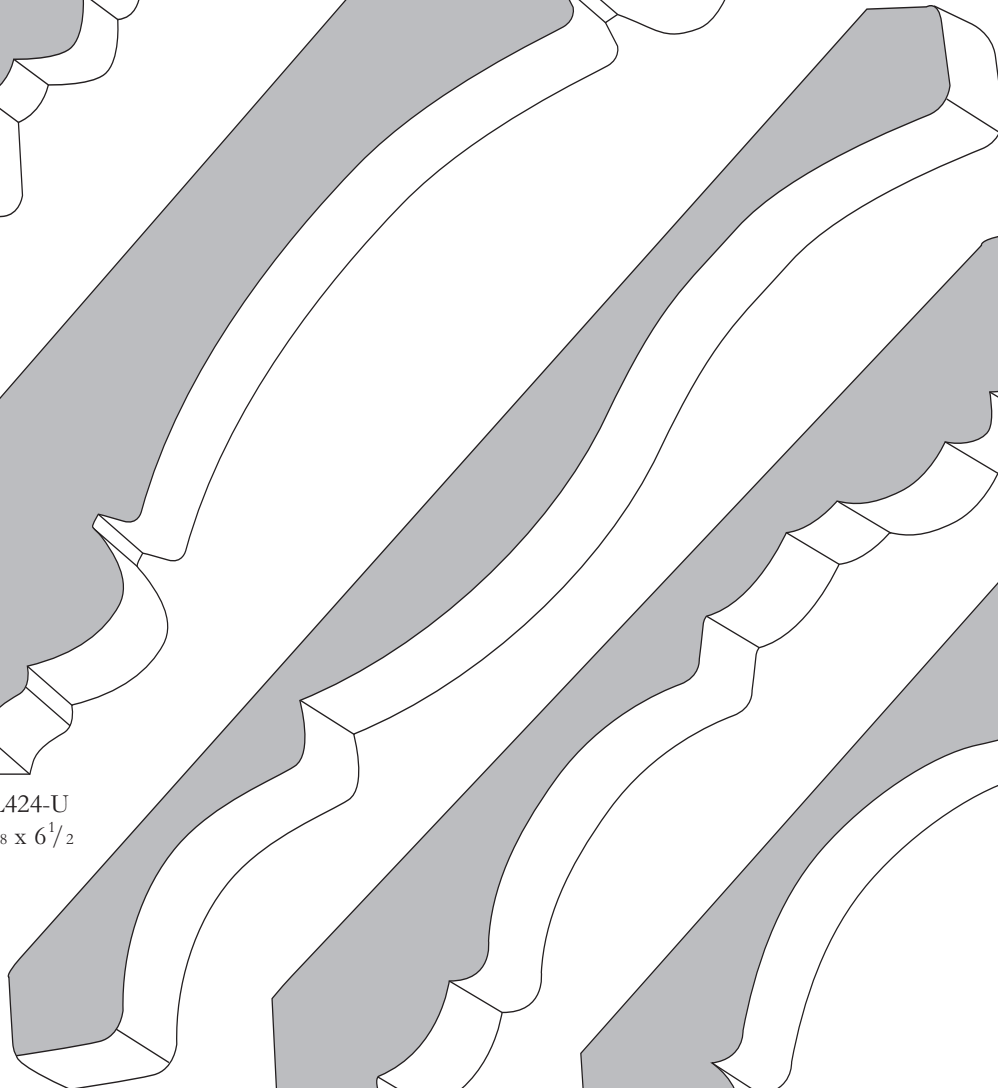

EL417-U
 $\frac{9}{16} \times 7\frac{1}{4}$

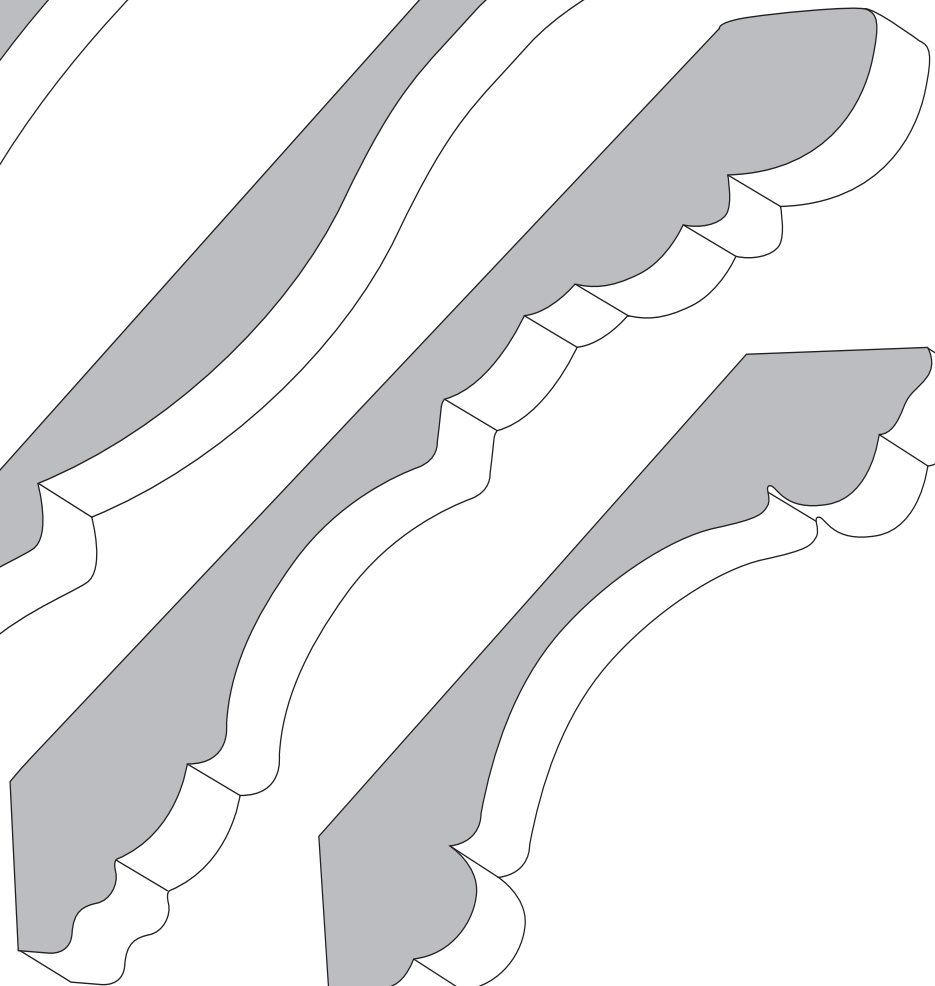

EL427-U
 $1\frac{1}{16} \times 6\frac{1}{2}$

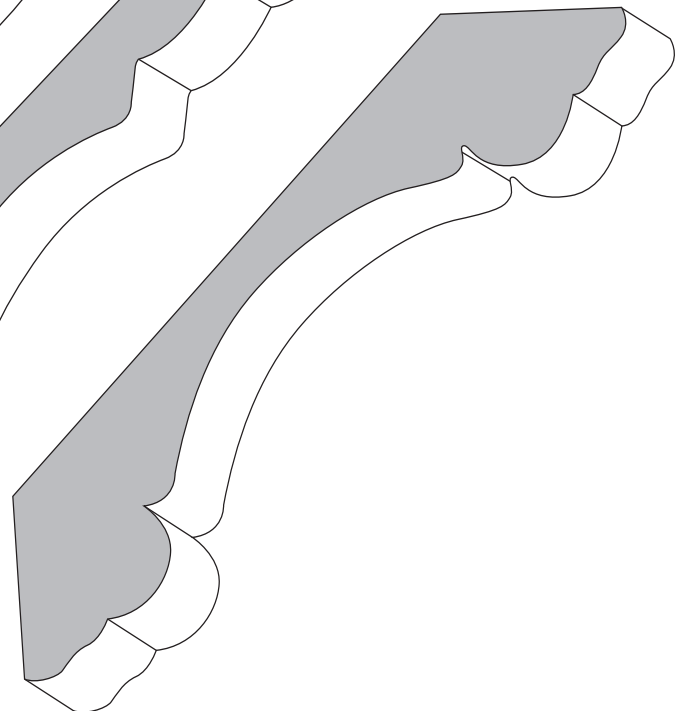

EL423-U
 $\frac{7}{8} \times 4\frac{5}{8}$



CROWN

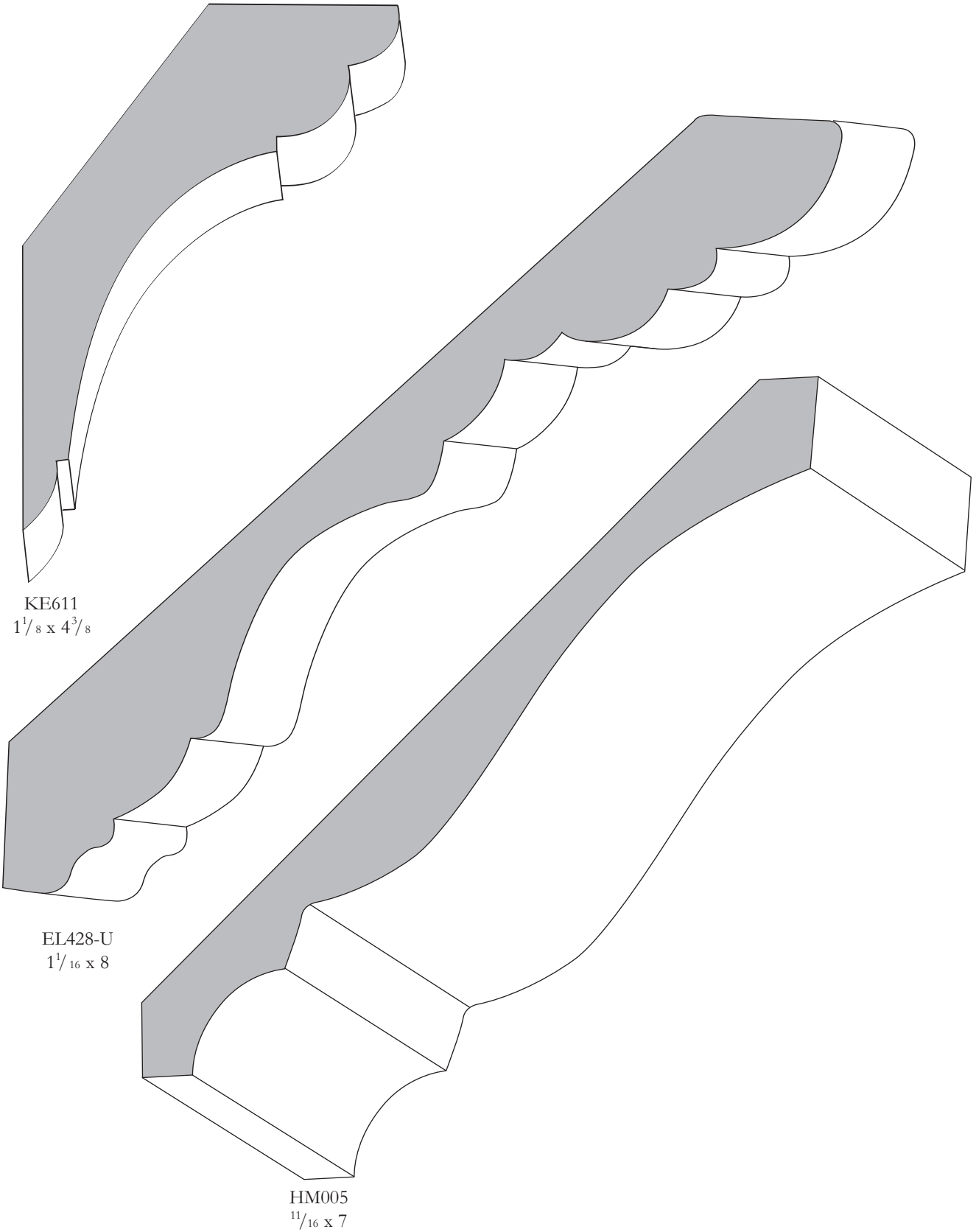

CROWN

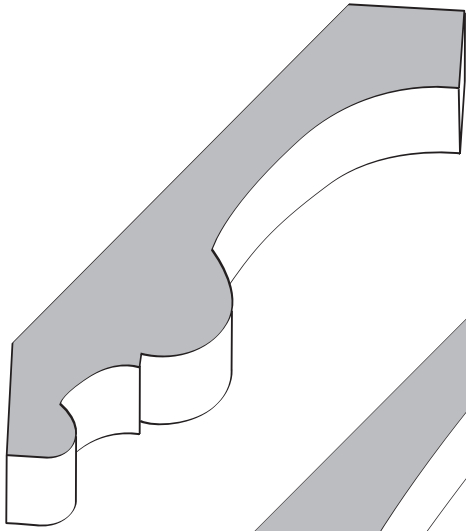

KE005
 $1\frac{1}{16} \times 3\frac{1}{4}$

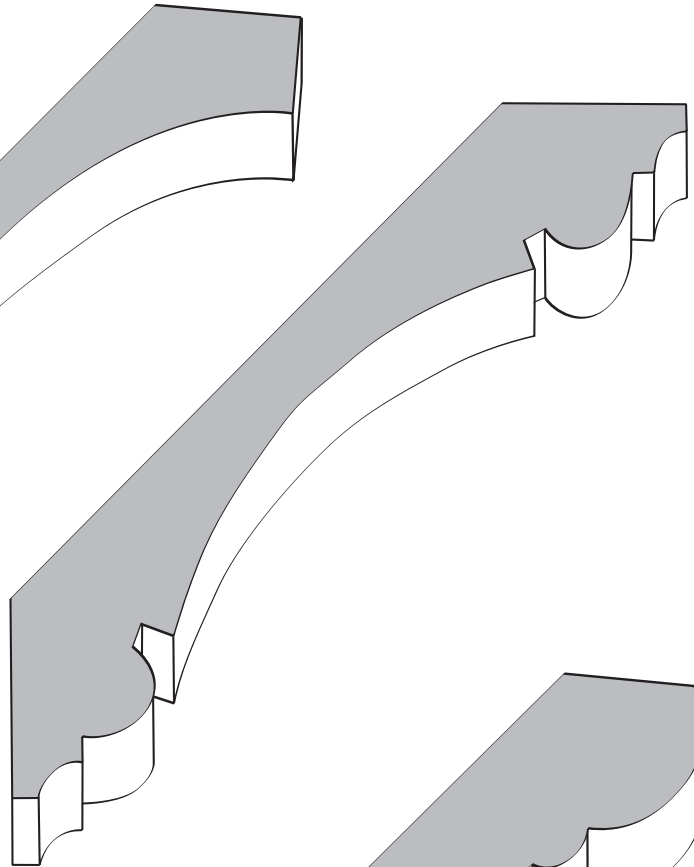

KE011-M
 $1\frac{5}{16} \times 4\frac{5}{8}$

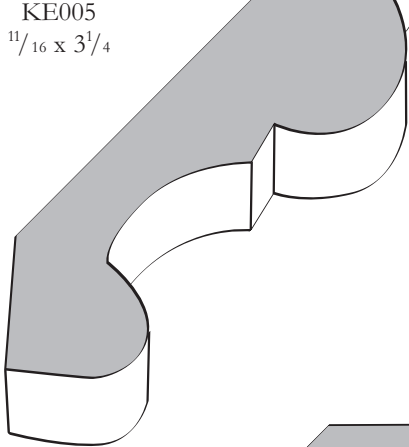

KE007
 $\frac{7}{8} \times 6\frac{9}{16}$

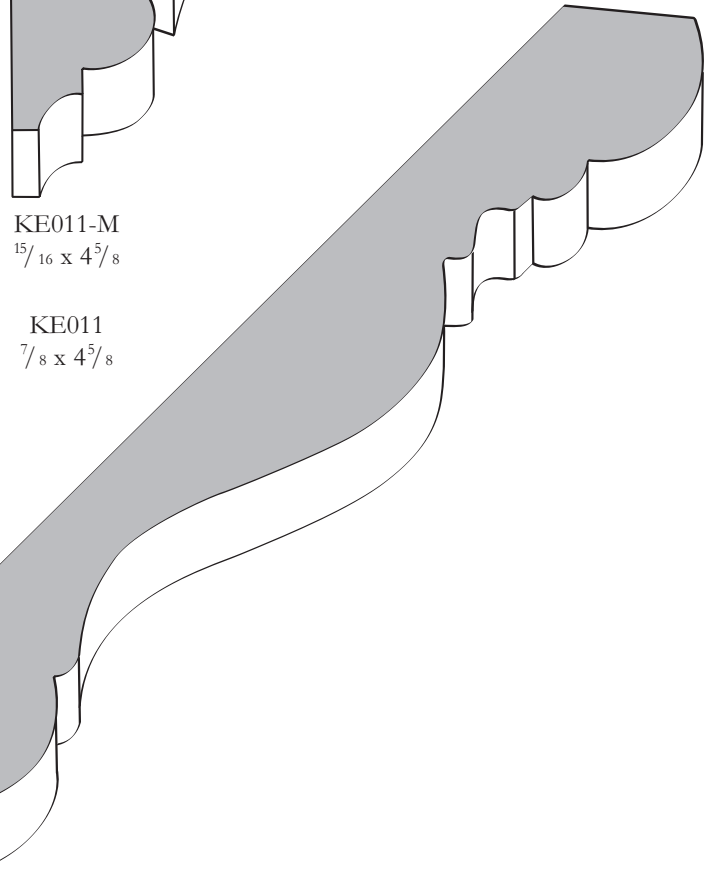

KE011
 $\frac{7}{8} \times 4\frac{5}{8}$

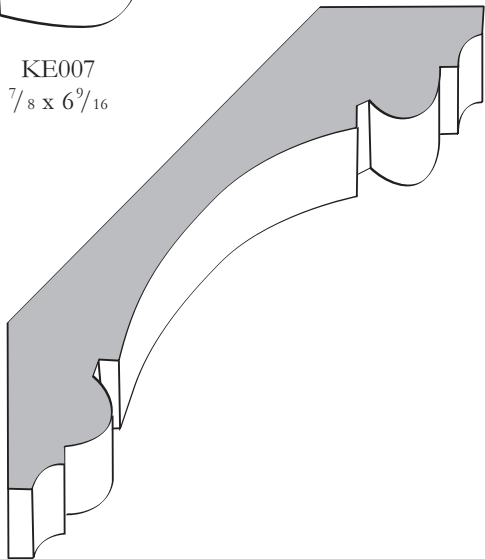

KE010-M KE010
 $1\frac{1}{16} \times 3\frac{7}{16}$ $1\frac{1}{16} \times 3\frac{7}{16}$

KE-46-M
 $\frac{3}{4} \times 5\frac{7}{8}$



CROWN

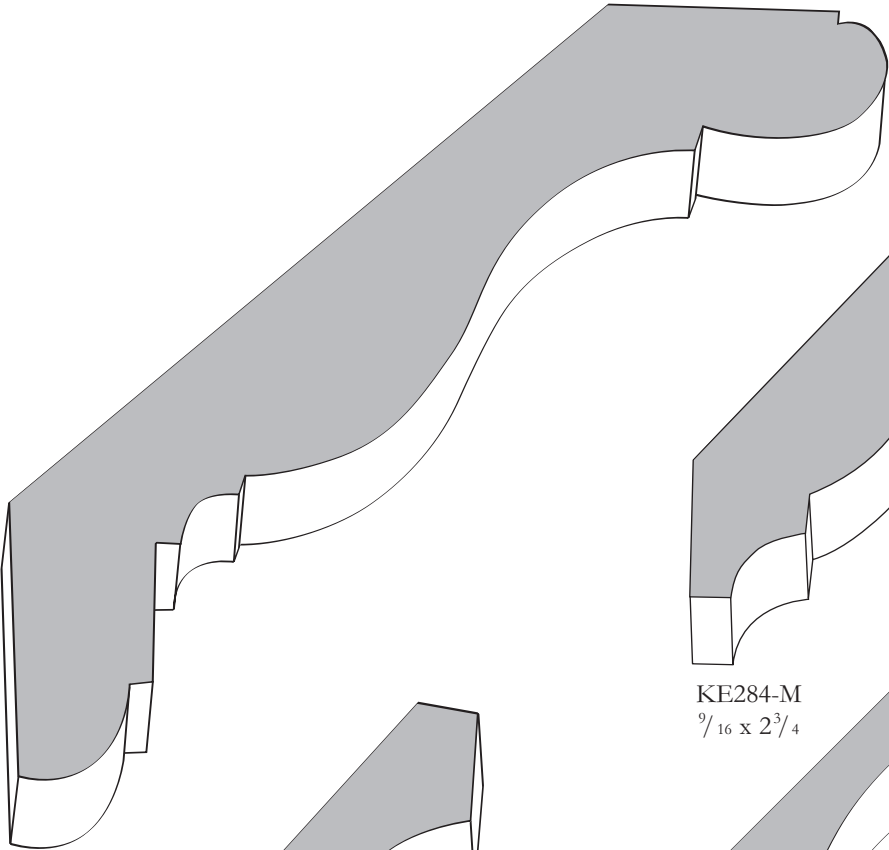

KE102-M
1 x 6

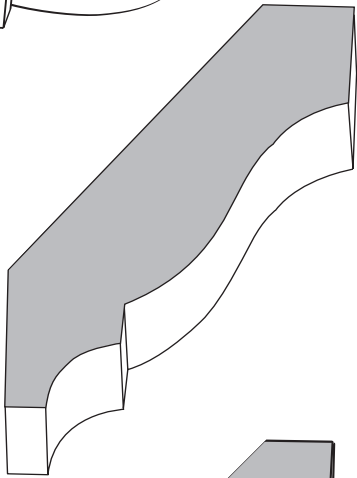

KE284-M
 $\frac{9}{16} \times 2\frac{3}{4}$



KE281
 $\frac{5}{8} \times 3\frac{1}{4}$

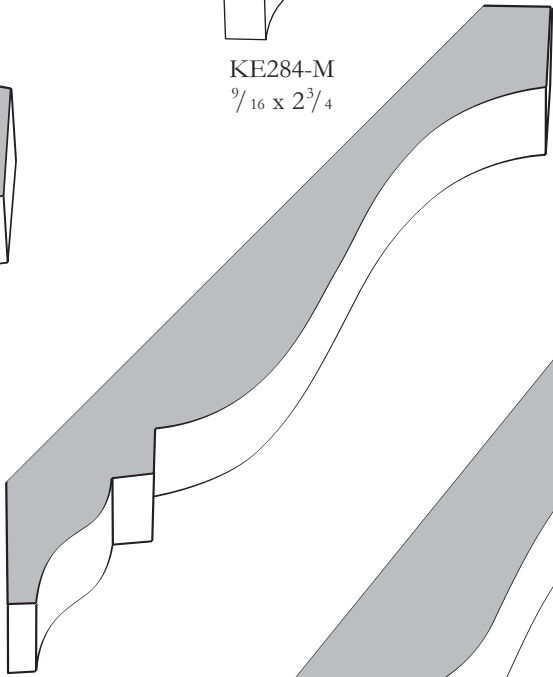

KE283
 $\frac{9}{16} \times 4\frac{1}{4}$

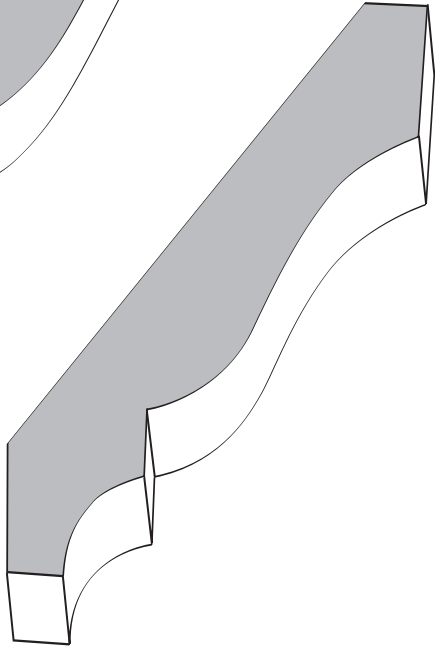

KE286-M
 $\frac{9}{16} \times 3\frac{5}{8}$



CROWN

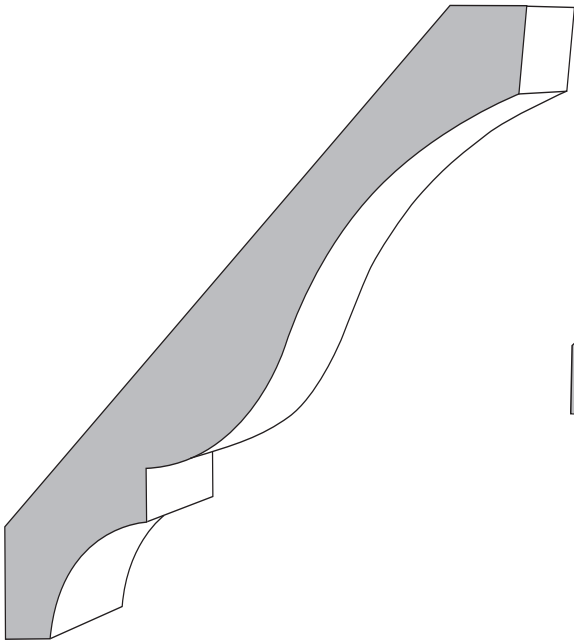

LS-48
 $\frac{9}{16} \times 4\frac{1}{4}$

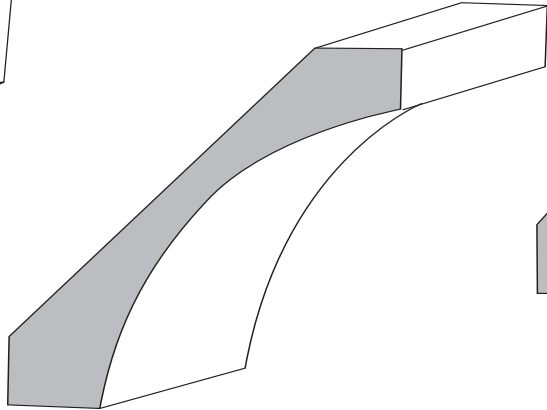

LS-82
 $\frac{9}{16} \times 2\frac{3}{4}$

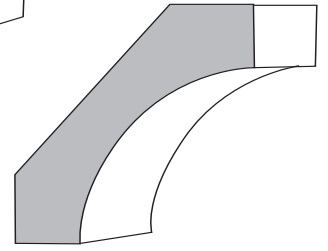

LS-85
 $\frac{9}{16} \times 1\frac{3}{4}$

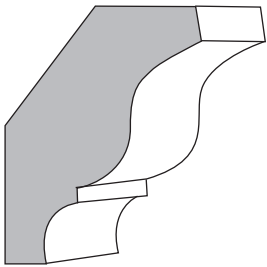

LS-68
 $\frac{9}{16} \times 1\frac{5}{8}$

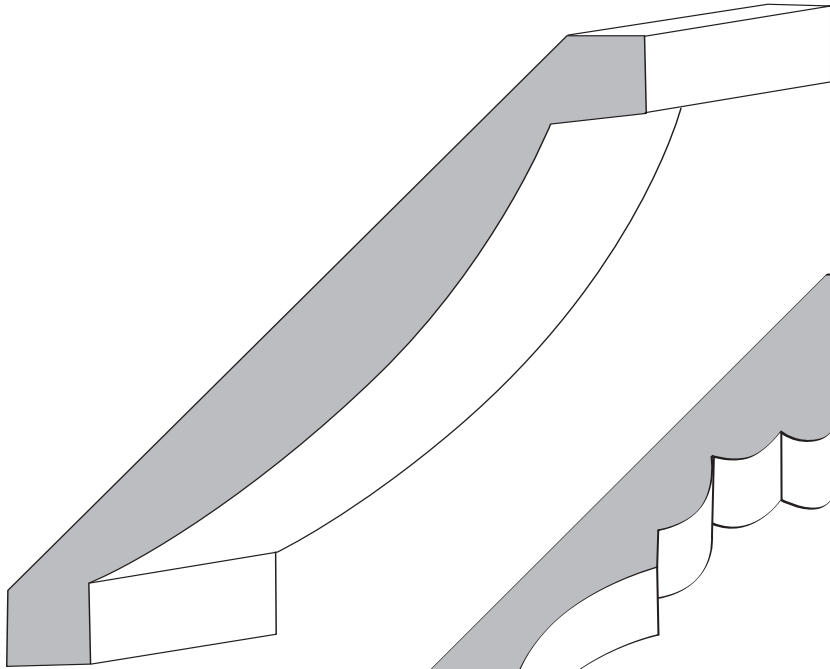

LS595
 $\frac{9}{16} \times 4\frac{5}{8}$

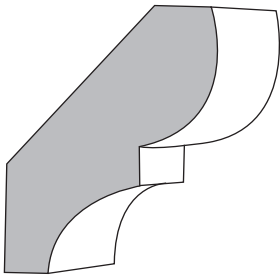

LS-74
 $\frac{9}{16} \times 1\frac{3}{4}$

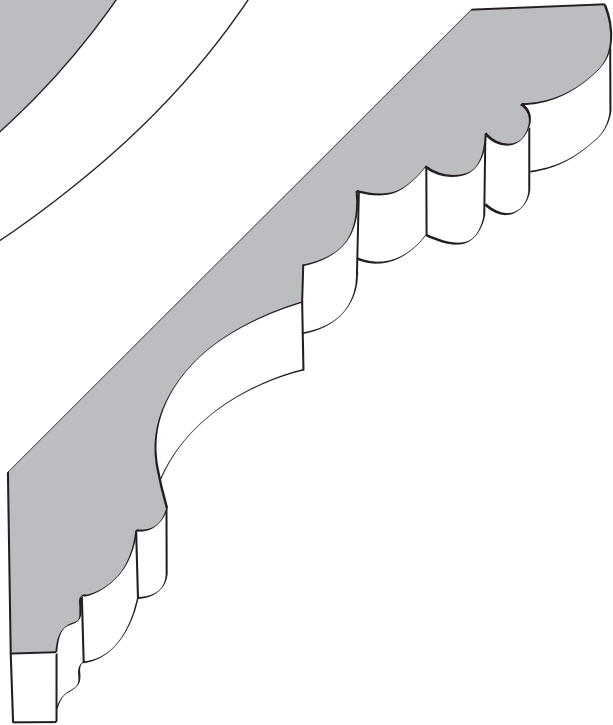

KE610
 $\frac{3}{4} \times 4\frac{3}{8}$



CROWN

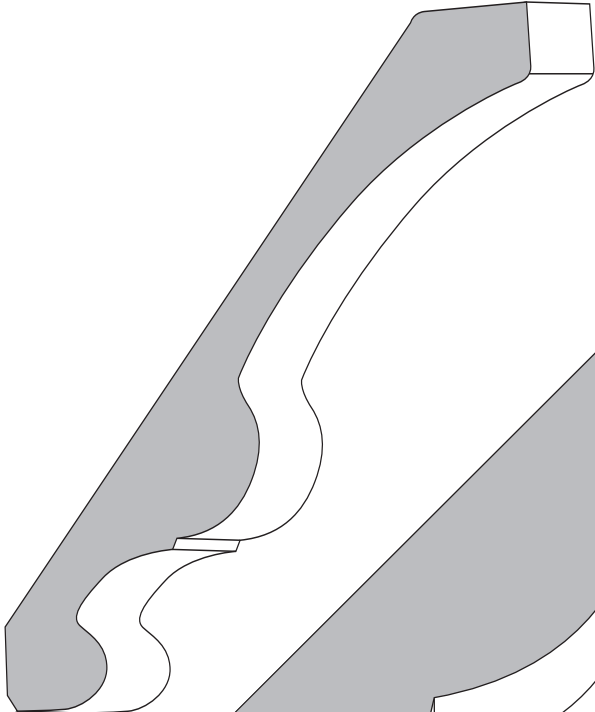

OR331
 $\frac{5}{8} \times 4\frac{1}{2}$

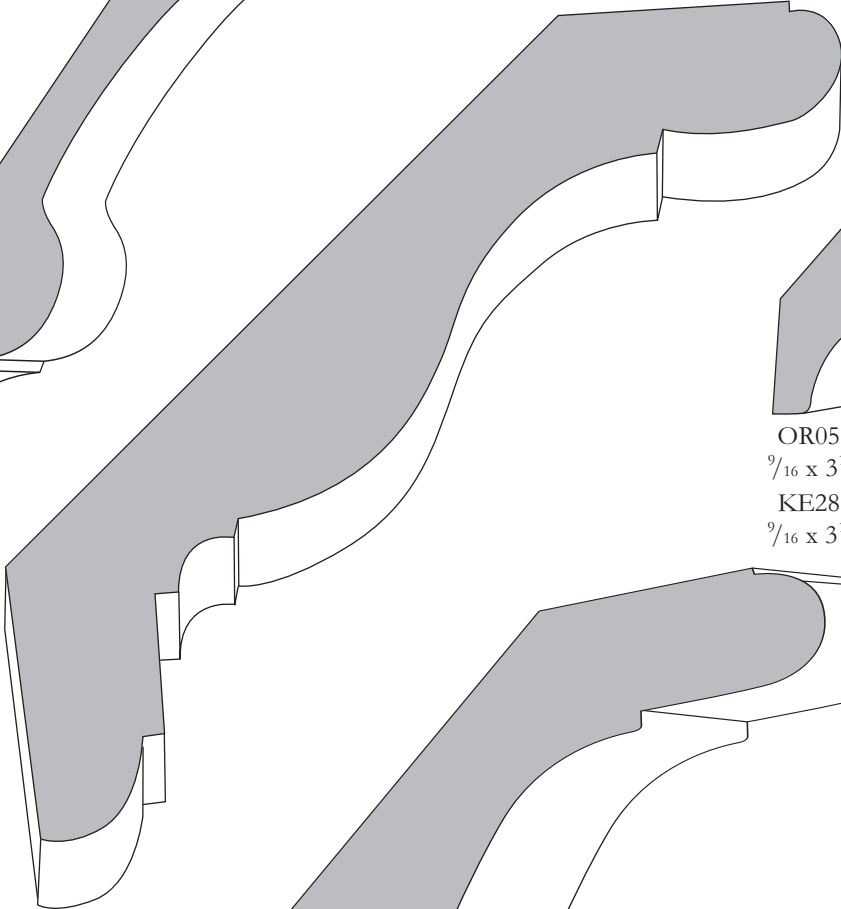

KE612
 $1\frac{1}{4} \times 6$

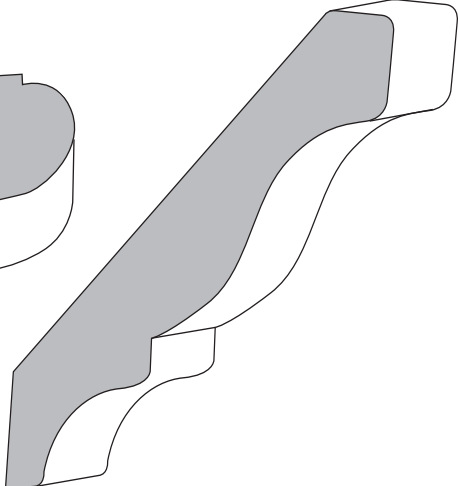

OR051
 $\frac{9}{16} \times 3\frac{1}{4}$
KE281
 $\frac{9}{16} \times 3\frac{1}{4}$

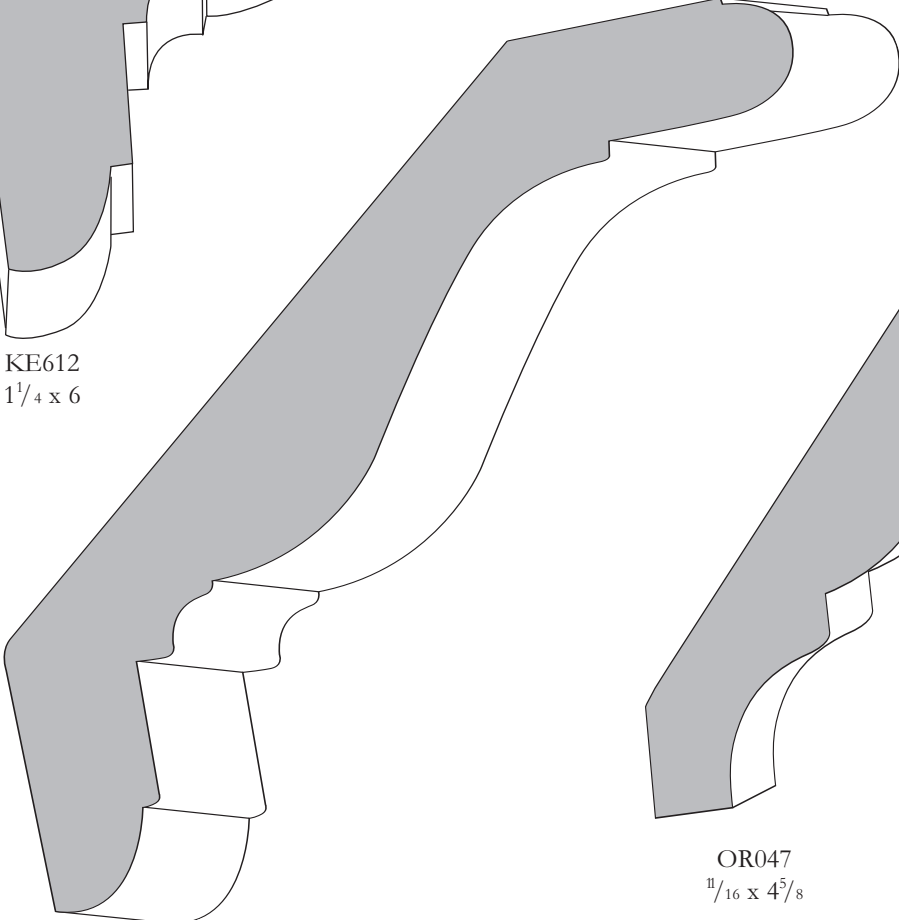

OR310-M
 $\frac{7}{8} \times 6$

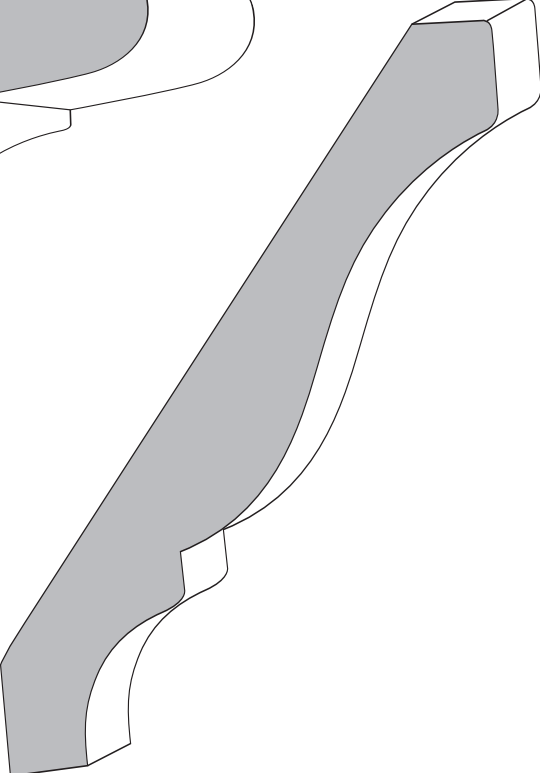

OR047
 $\frac{11}{16} \times 4\frac{5}{8}$



CROWN

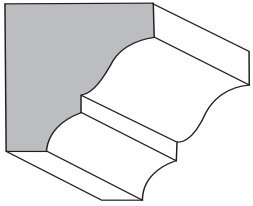

S3300
 $\frac{3}{4} \times \frac{3}{4}$

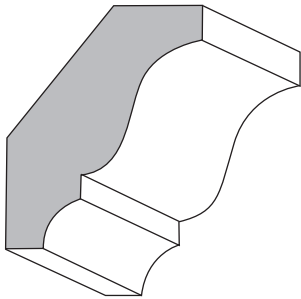

S3301
 $\frac{1}{2} \times 1 \frac{5}{8}$

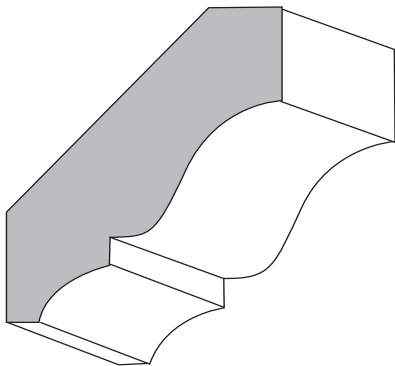

S3302
 $\frac{9}{16} \times 2 \frac{1}{4}$

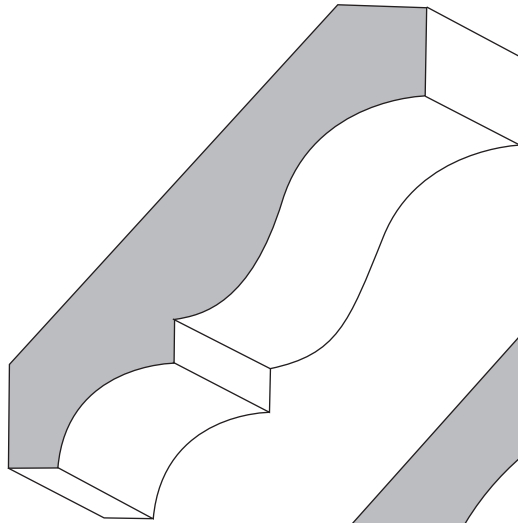

S3304
 $\frac{9}{16} \times 3 \frac{1}{4}$

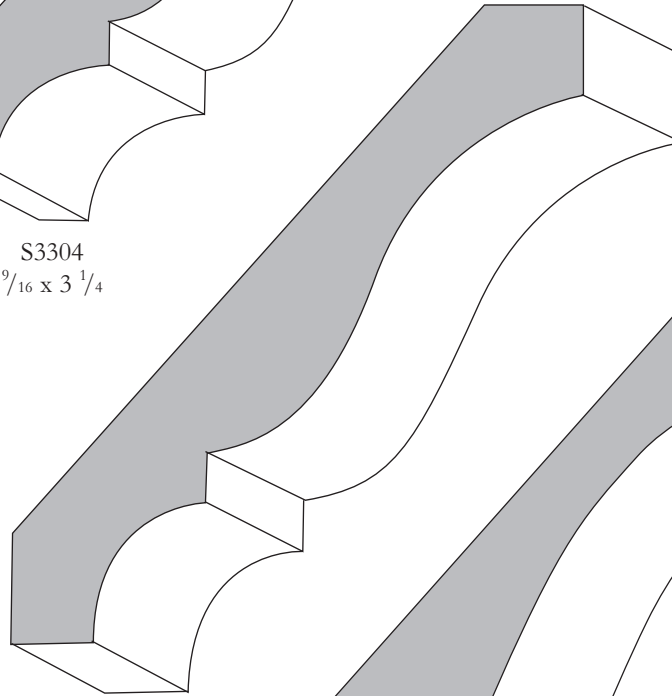

S3305
 $\frac{5}{8} \times 4 \frac{1}{2}$

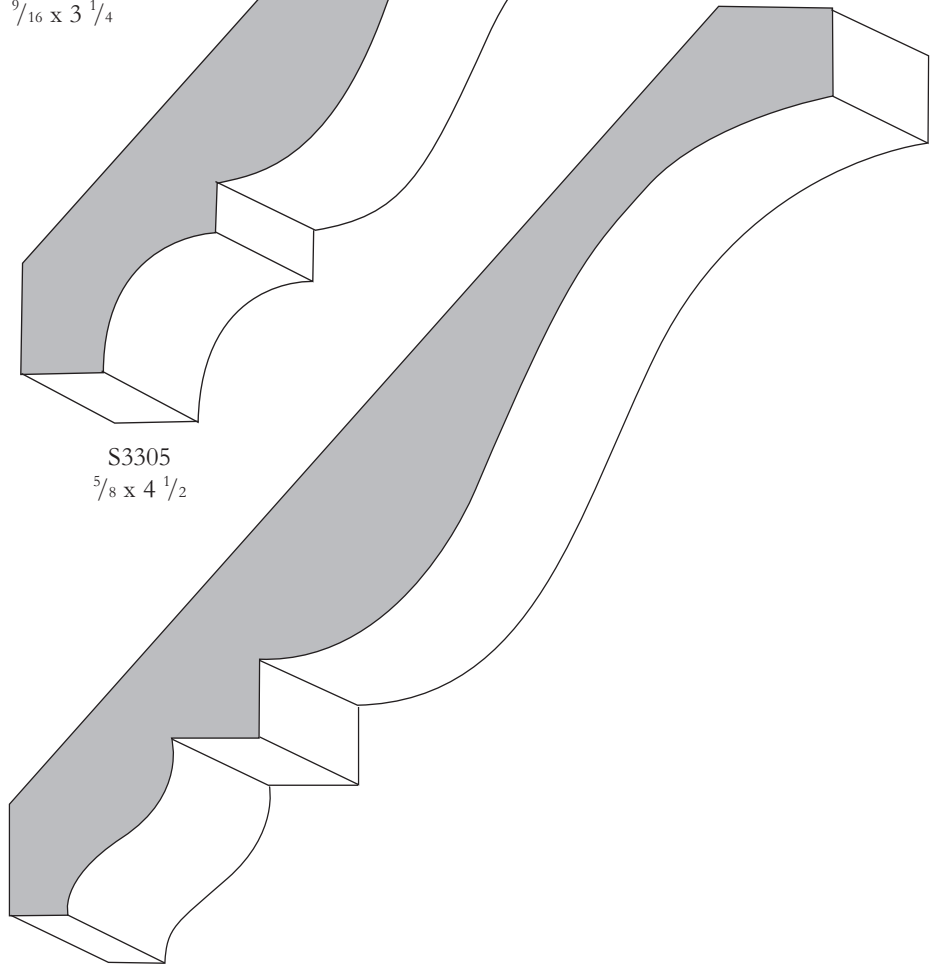

S3307
 $\frac{3}{4} \times 6 \frac{3}{8}$

CROWN

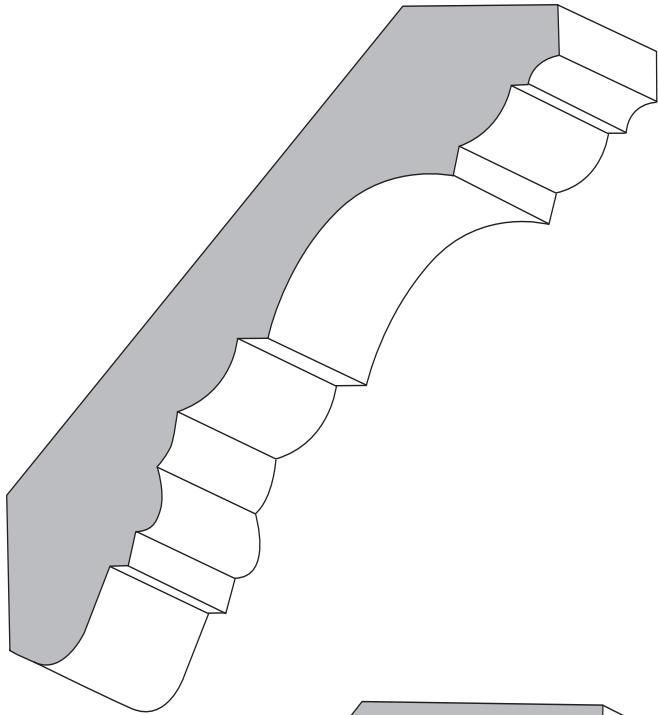

S3308
 $1\frac{11}{16} \times 4\frac{7}{16}$

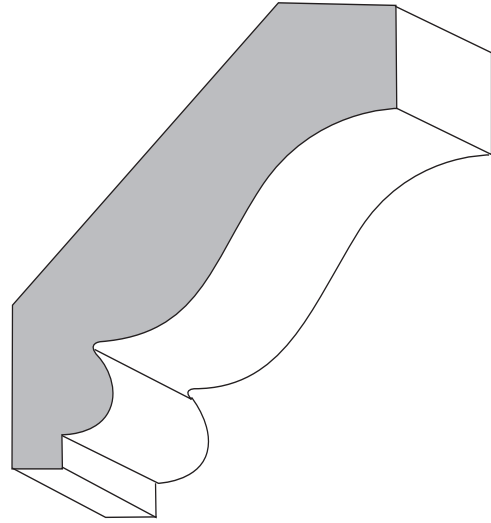

S3316
 $\frac{3}{4} \times 3\frac{1}{8}$

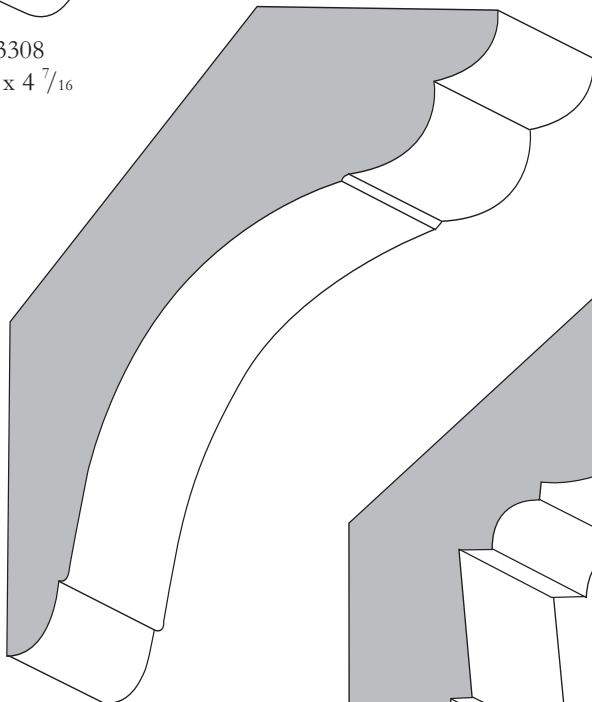

S3309
 $1\frac{1}{16} \times 4\frac{5}{16}$

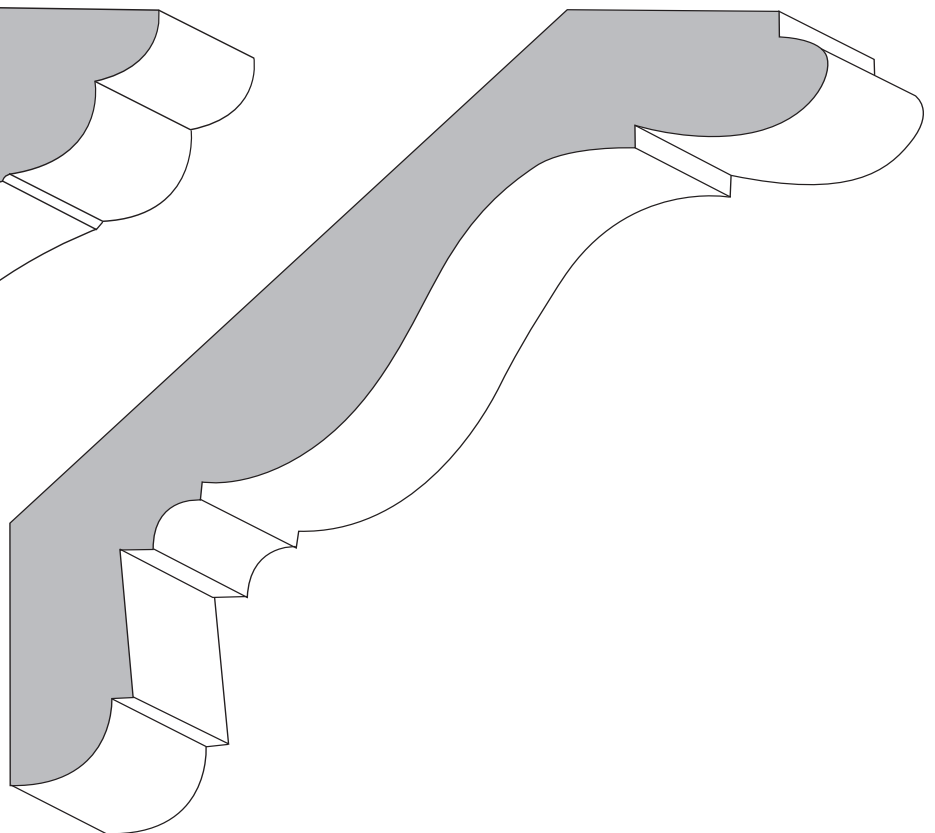

S3310
 $1\frac{1}{4} \times 6$



CROWN

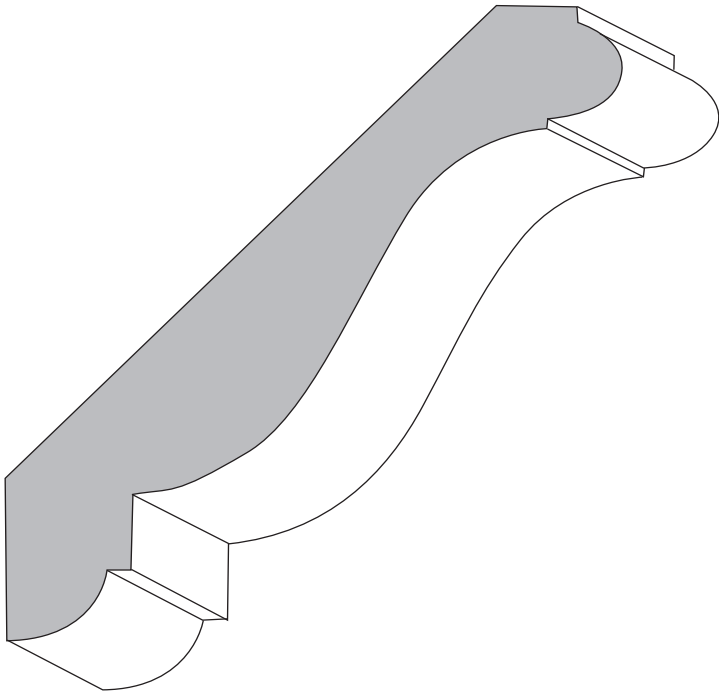

S3311
 $\frac{3}{4} \times 4 \frac{1}{2}$

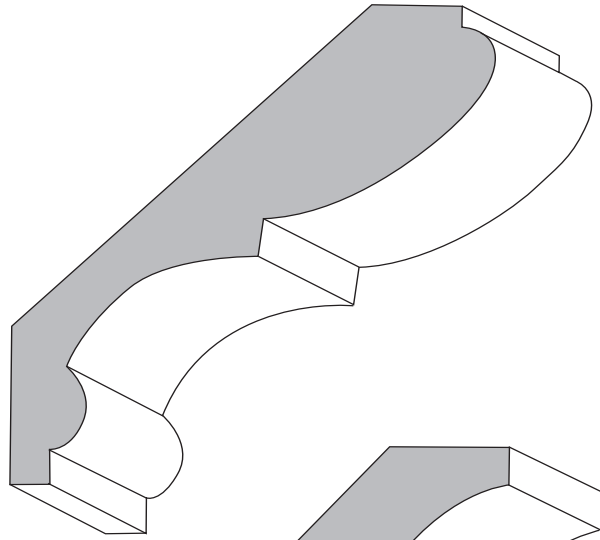

S3313
 $\frac{11}{16} \times 3 \frac{3}{8}$

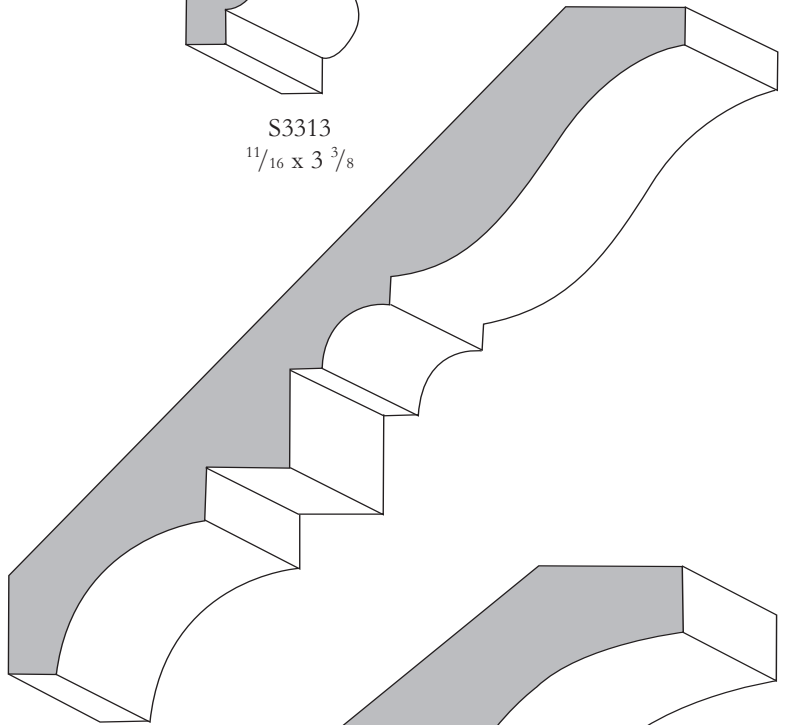

S3315
 $\frac{11}{16} \times 5$

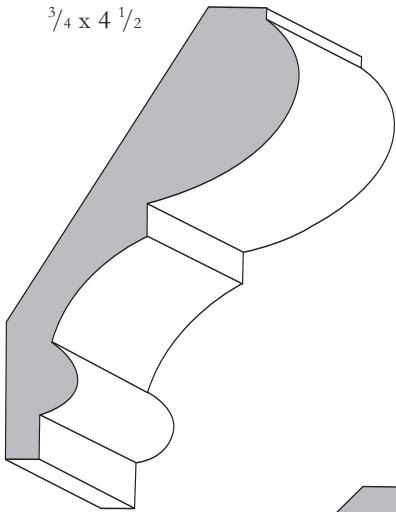

S3312
 $\frac{11}{16} \times 2 \frac{13}{16}$

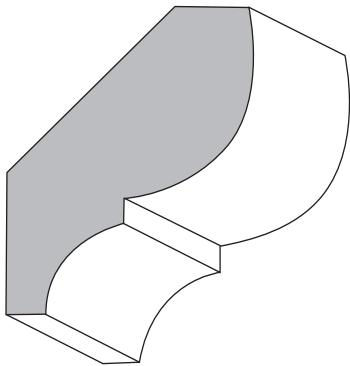

S3323
 $\frac{11}{16} \times 2$

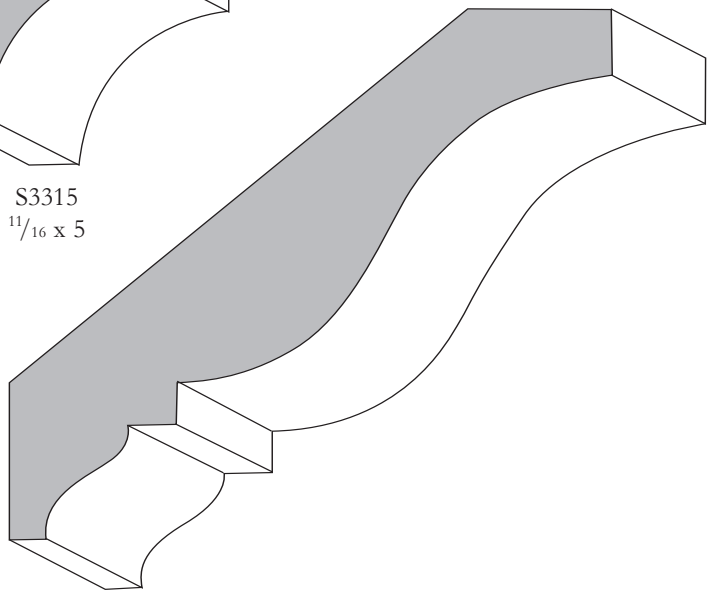

S3318
 $\frac{3}{4} \times 4 \frac{1}{8}$



CROWN

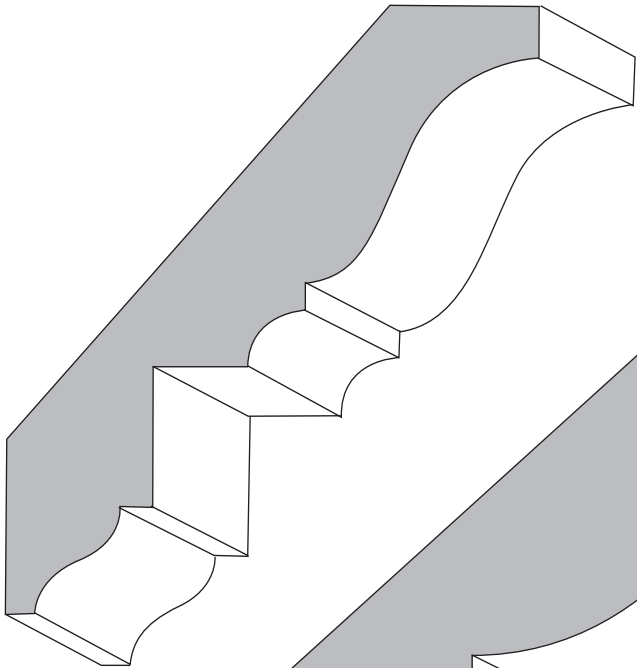

S3317
 $\frac{3}{4} \times 4 \frac{3}{16}$

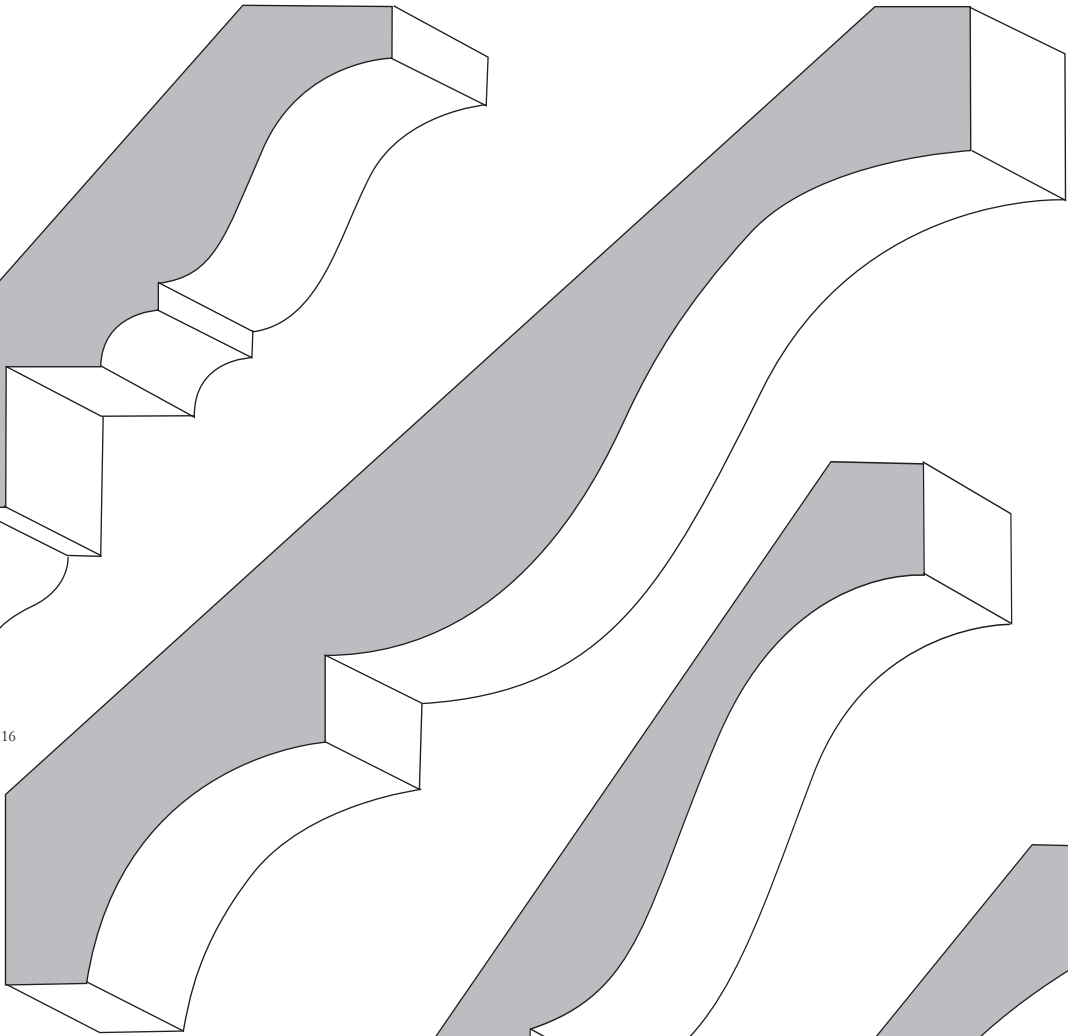

S3326
 $\frac{7}{8} \times 7 \frac{1}{4}$

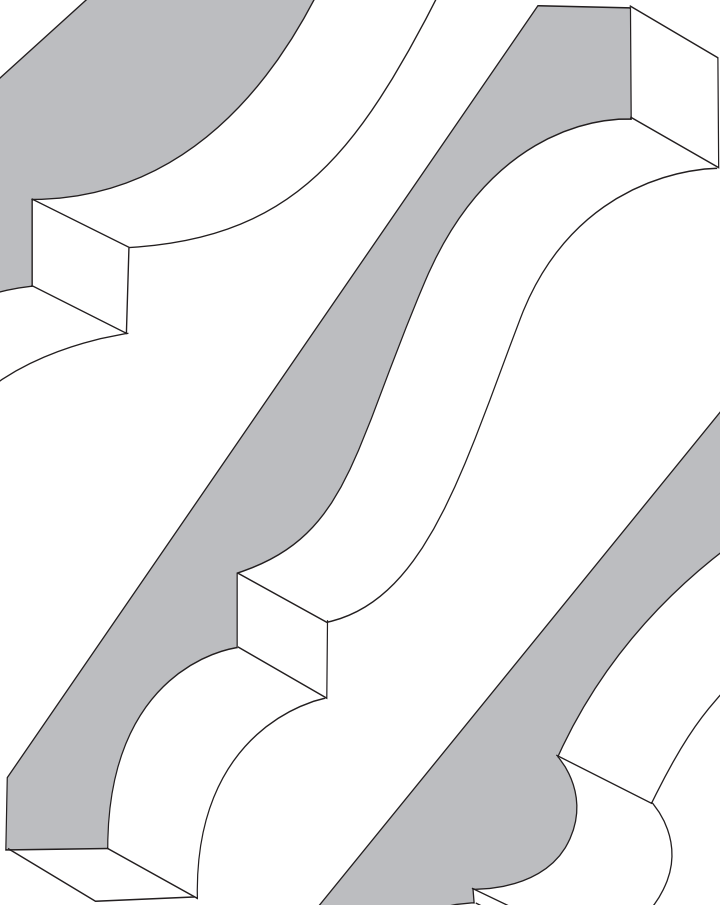

S3325
 $\frac{3}{4} \times 5 \frac{1}{2}$

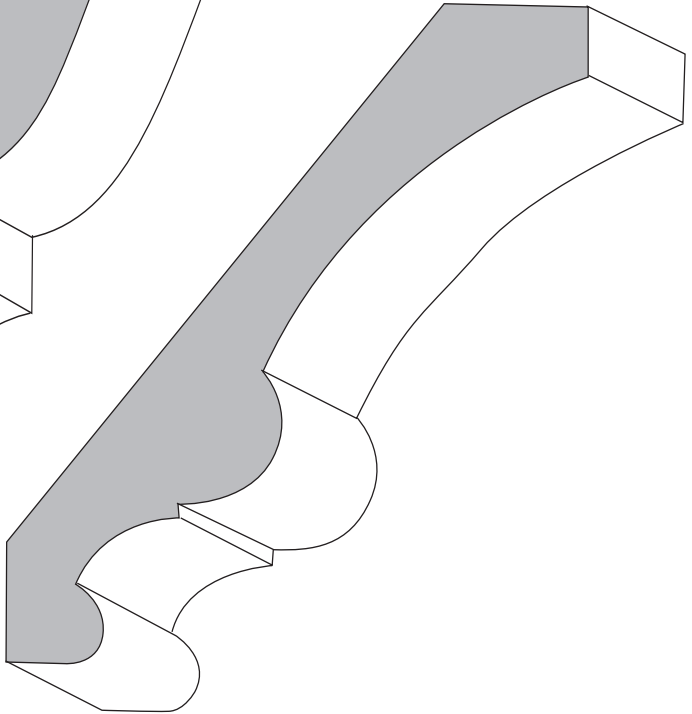

S3331
 $\frac{13}{16} \times 4 \frac{5}{8}$



CROWN

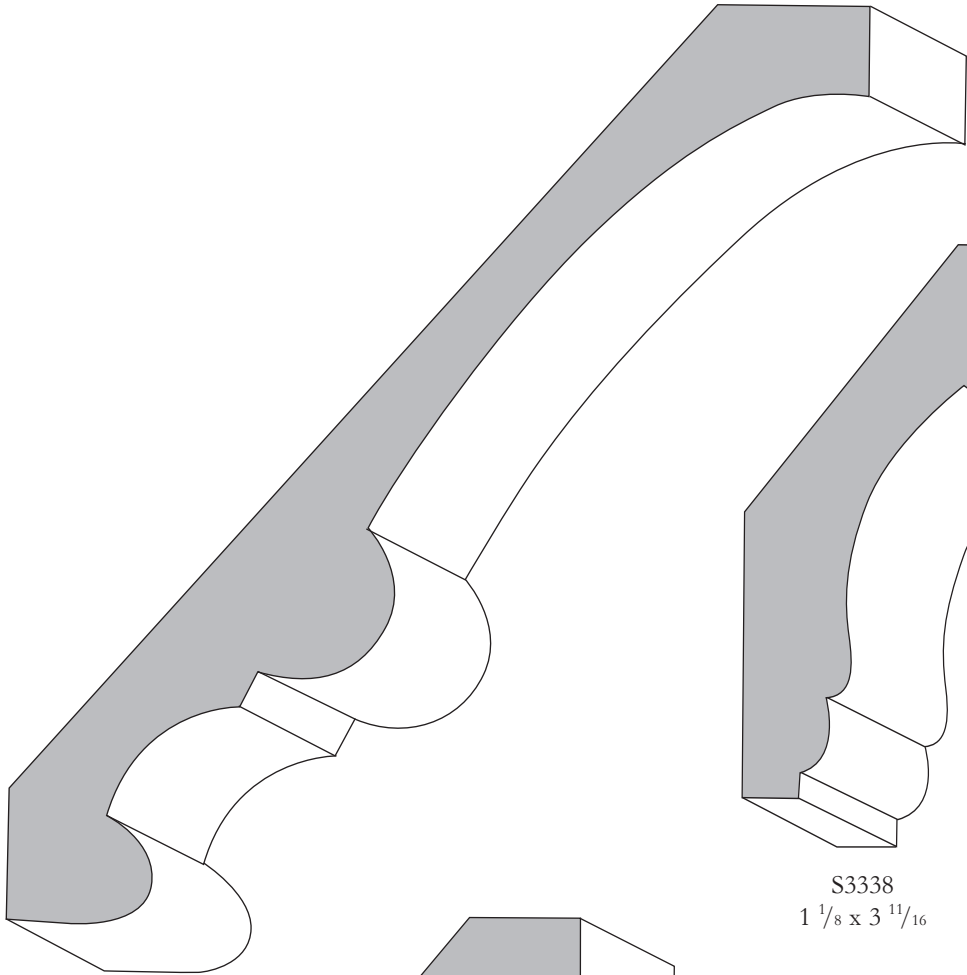

S3332
 $\frac{7}{8} \times 6 \frac{1}{2}$

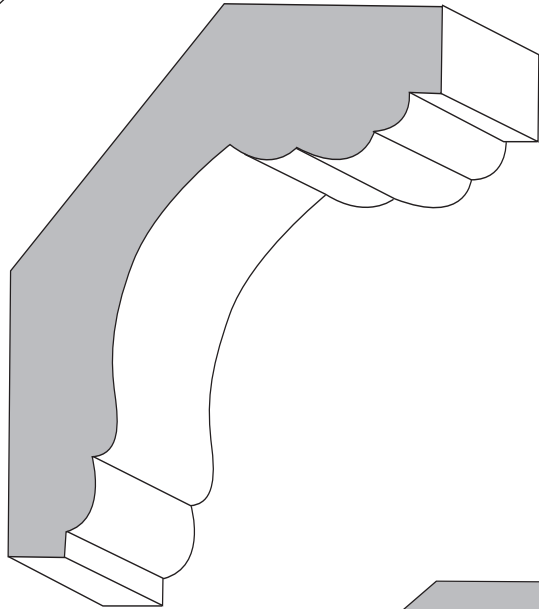

S3338
 $1 \frac{1}{8} \times 3 \frac{11}{16}$

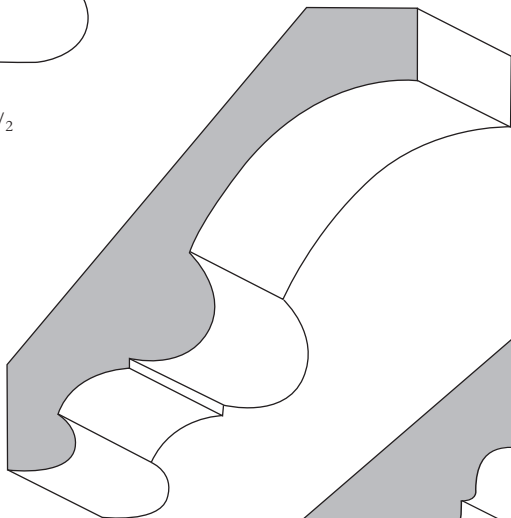

S3333
 $\frac{11}{16} \times 3 \frac{1}{4}$

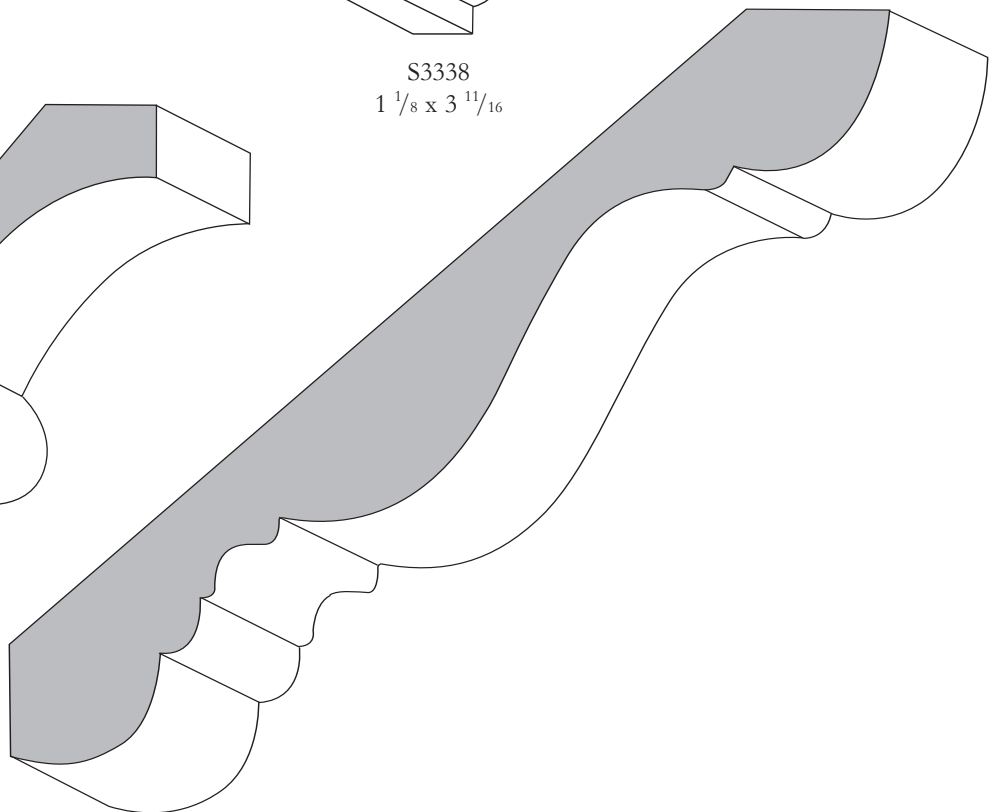

S3339
 $\frac{3}{4} \times 6$



CROWN

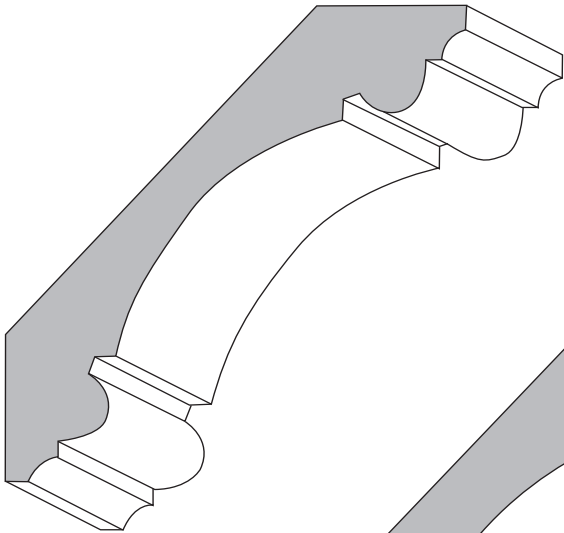

S3343
 $\frac{3}{4} \times 3 \frac{7}{16}$

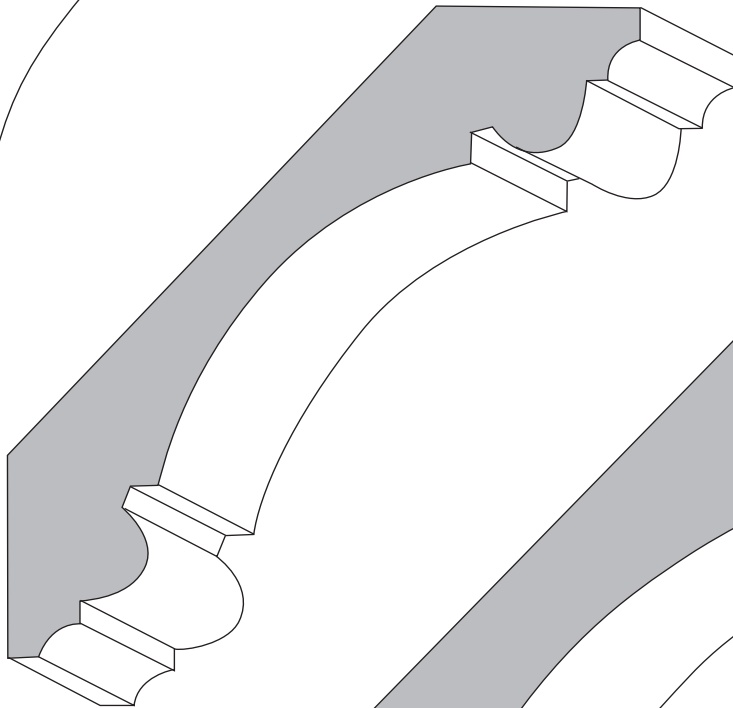

S3344
 $\frac{7}{8} \times 4 \frac{5}{8}$

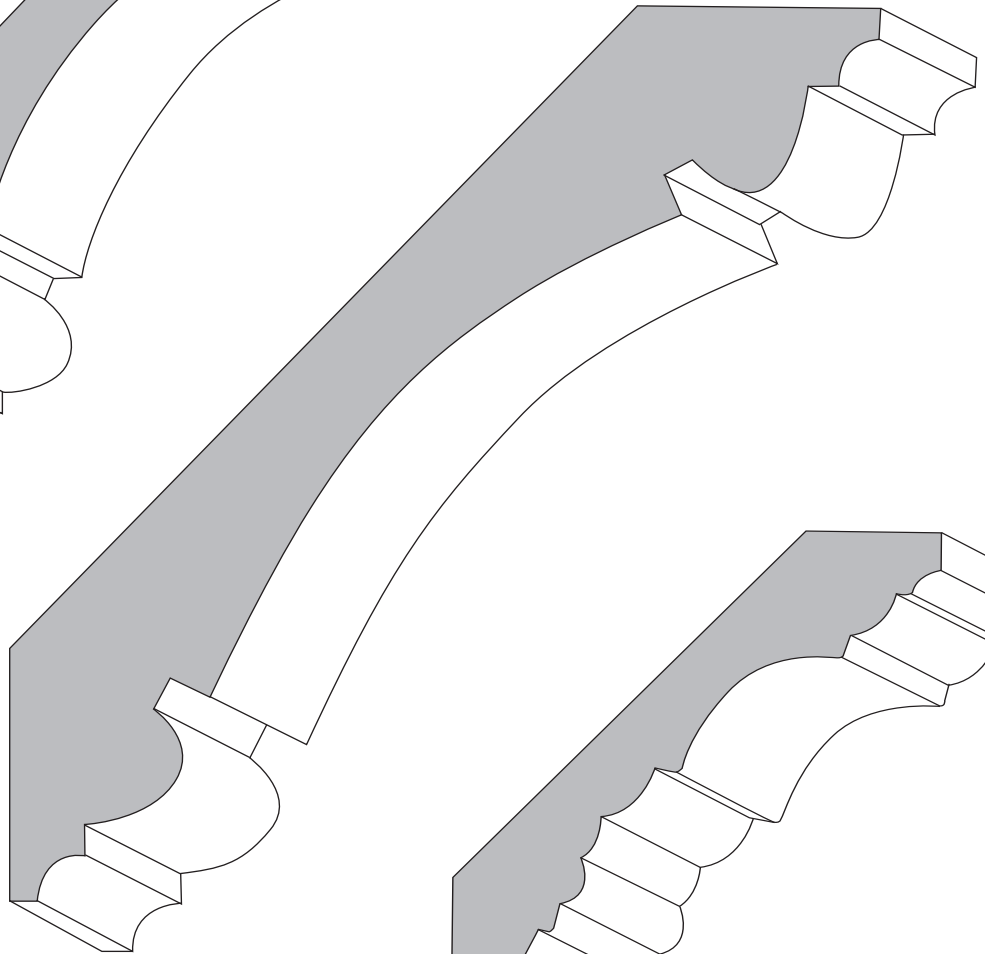

S3345
 $1 \frac{1}{8} \times 6 \frac{1}{2}$

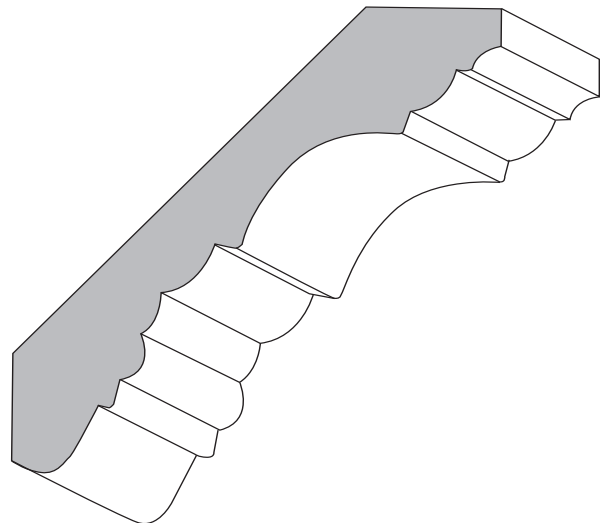

S3357
 $\frac{9}{16} \times 3 \frac{7}{16}$



CROWN

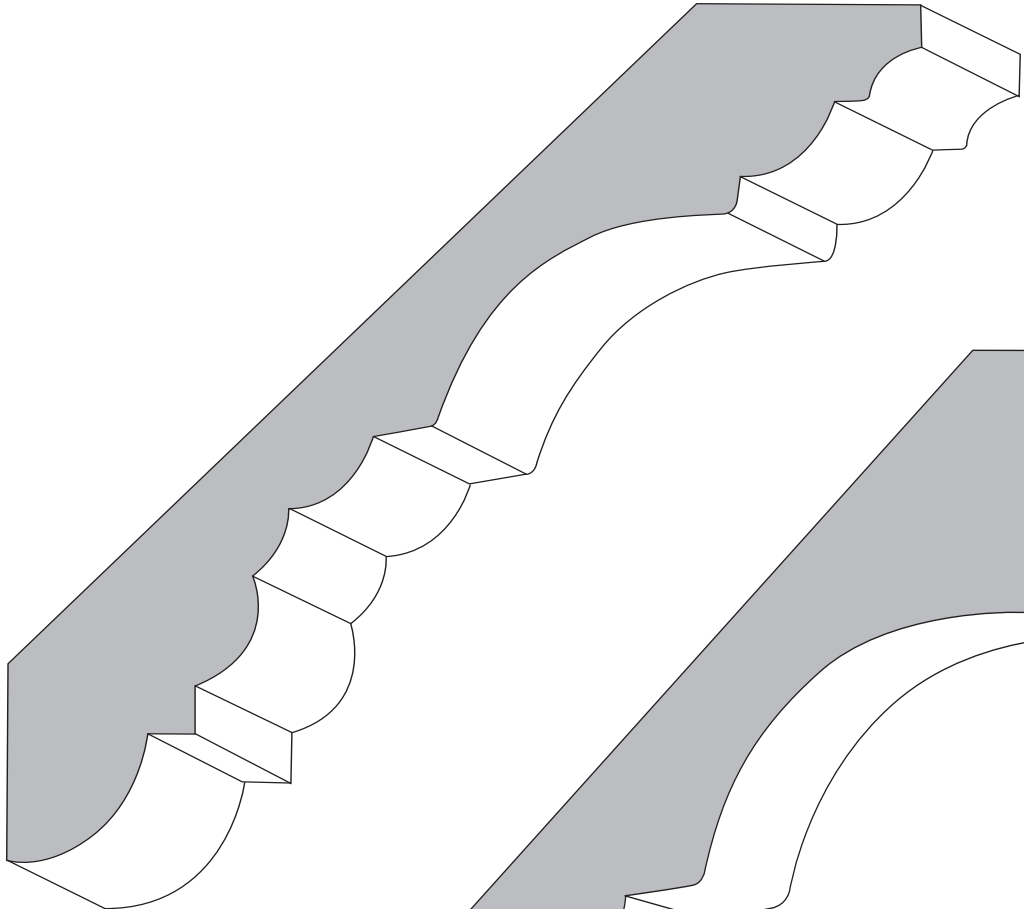

S3359
 $\frac{7}{8} \times 6 \frac{1}{2}$

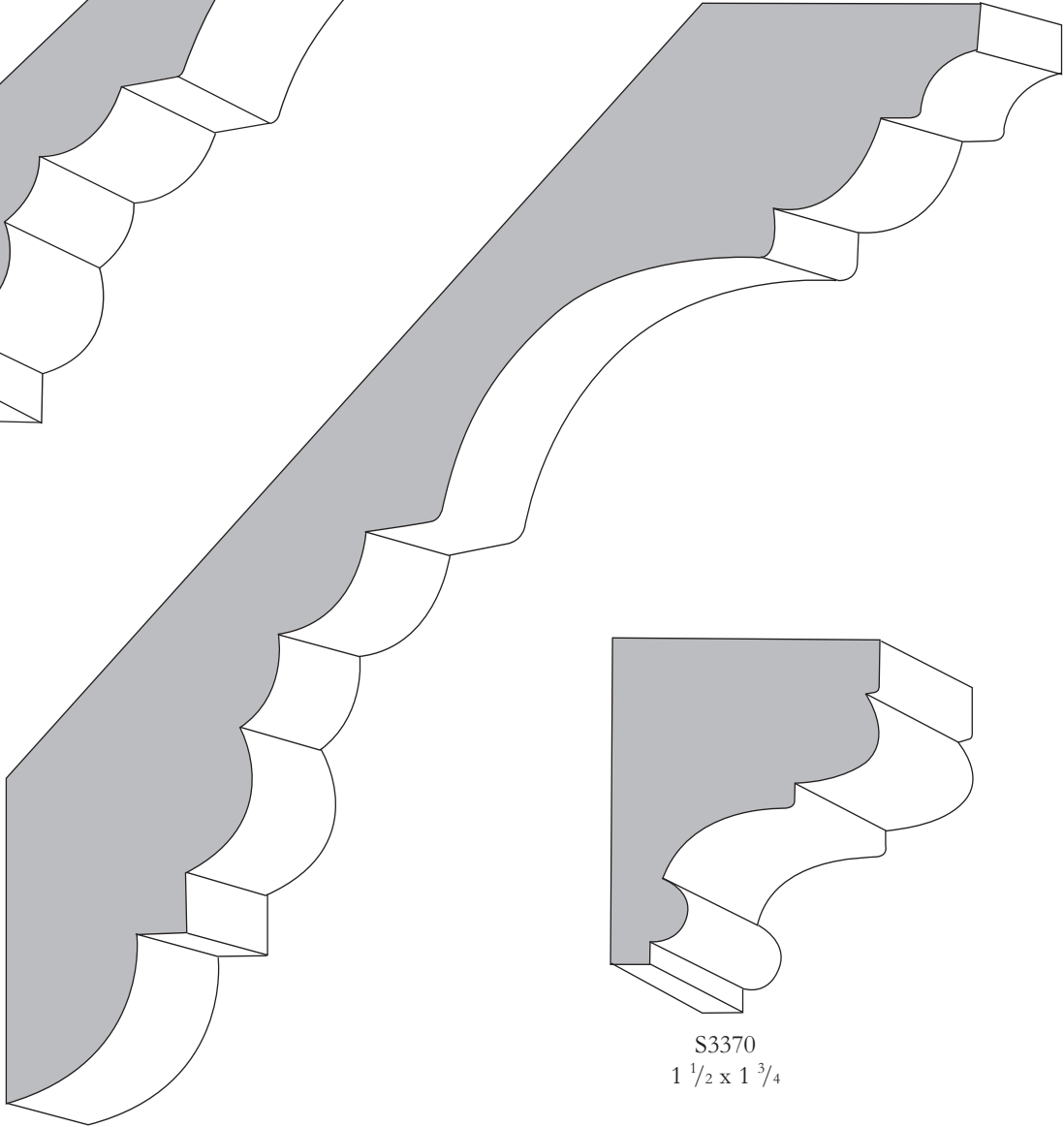

S3360
 $1 \frac{1}{4} \times 8$

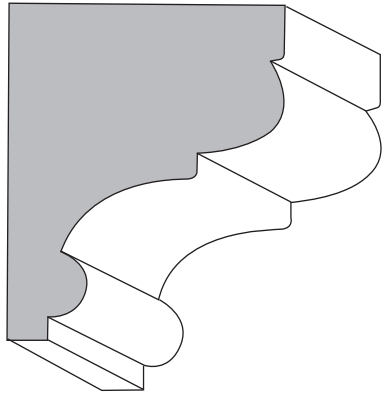

S3370
 $1 \frac{1}{2} \times 1 \frac{3}{4}$

CROWN

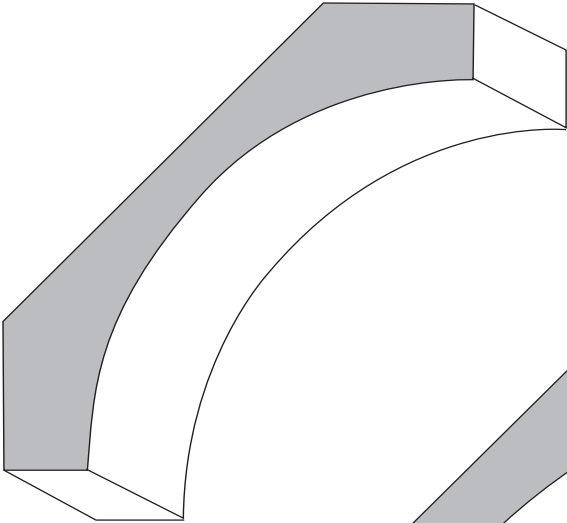

S3361
 $\frac{7}{8} \times 3 \frac{1}{2}$

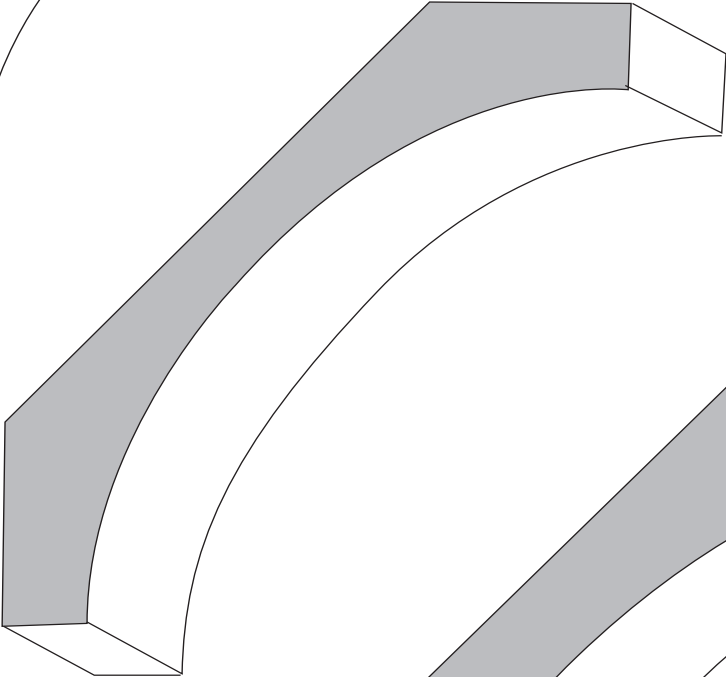

S3362
 $1 \times 4 \frac{5}{8}$

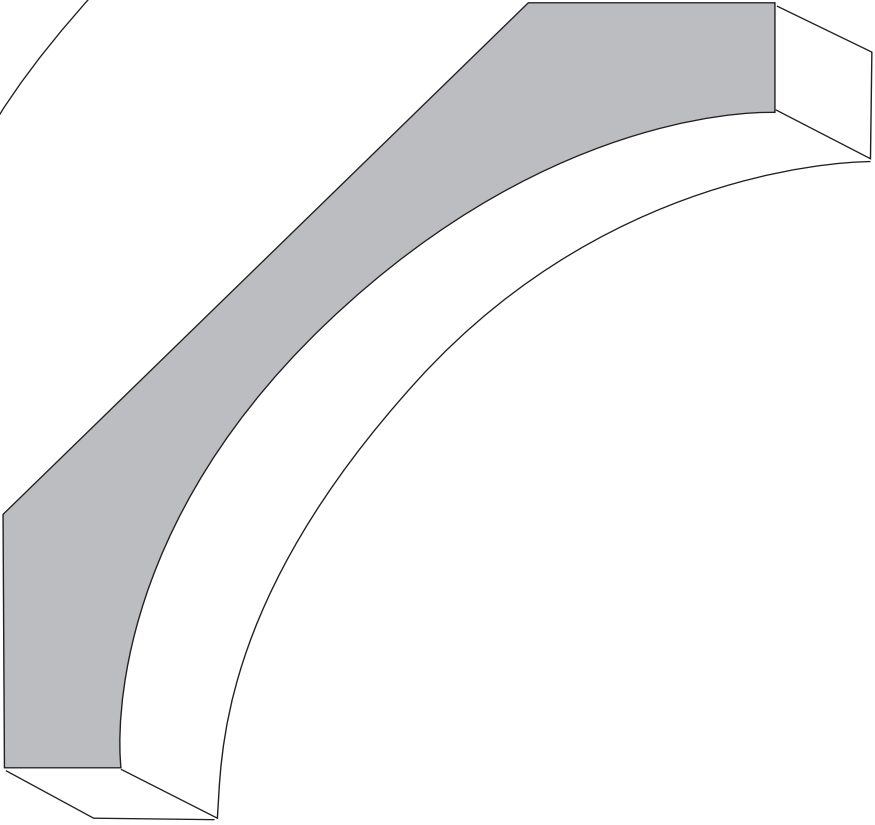

S3363
 $1 \frac{5}{16} \times 5 \frac{3}{4}$



CROWN

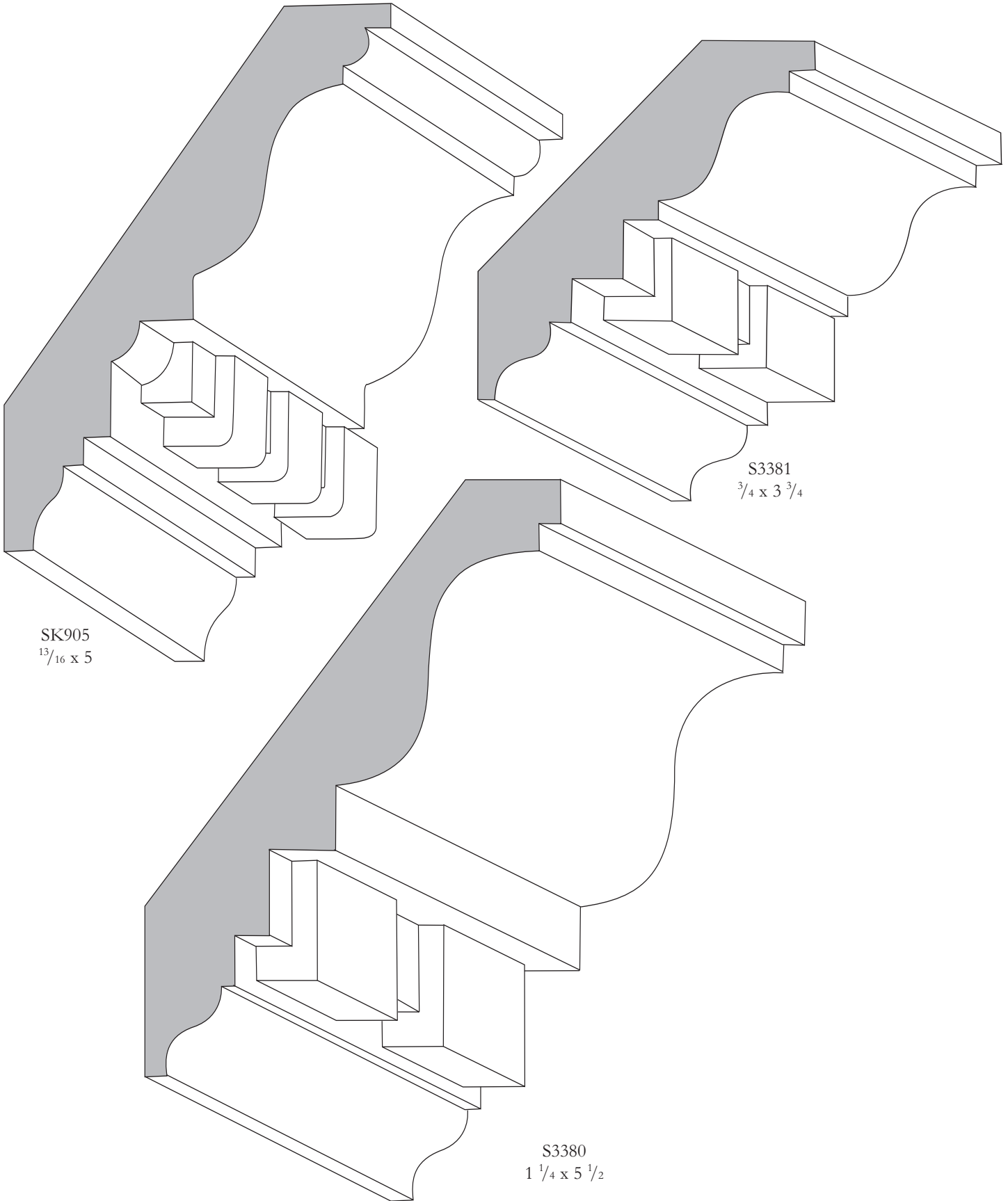

CROWN

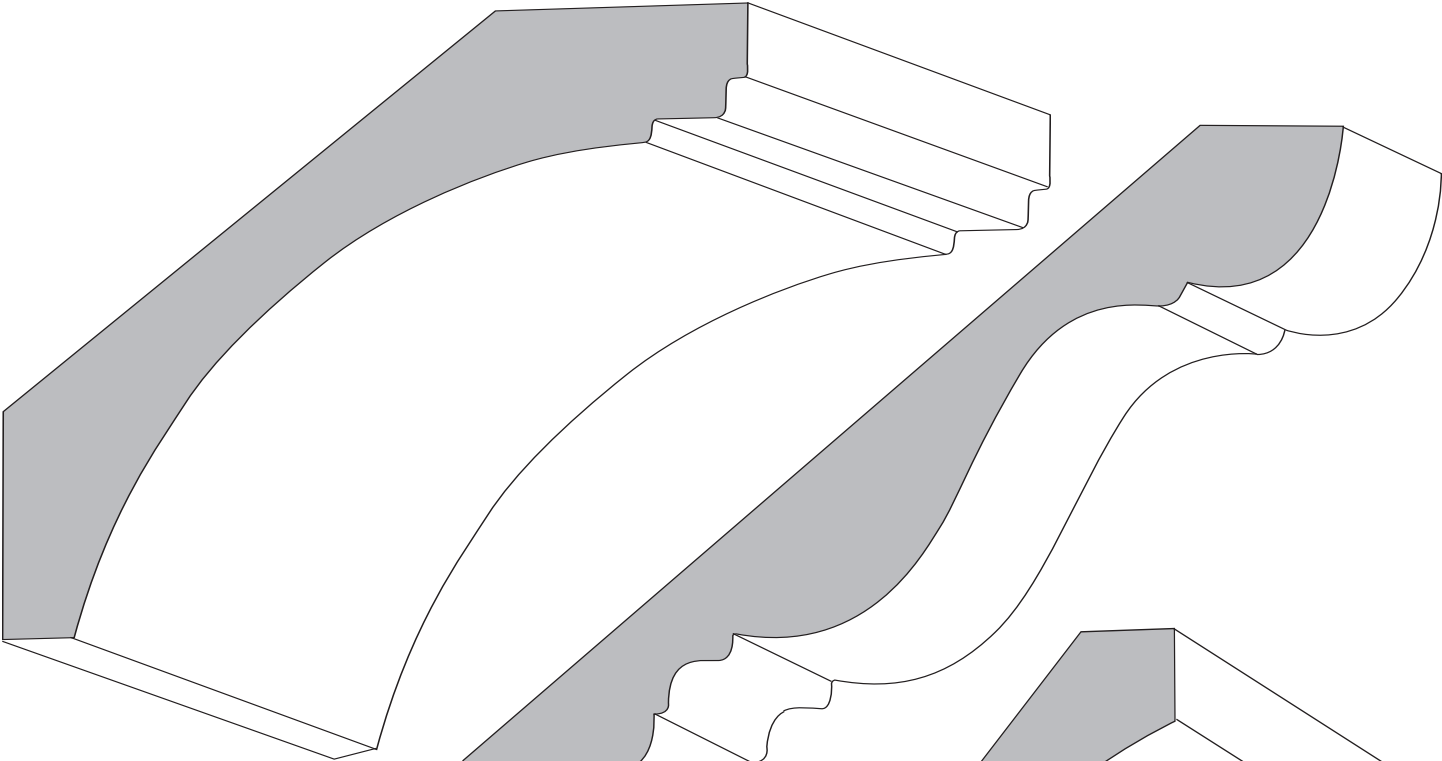

SK919
1 1/4 x 5 1/8

S3393
3/4 x 6

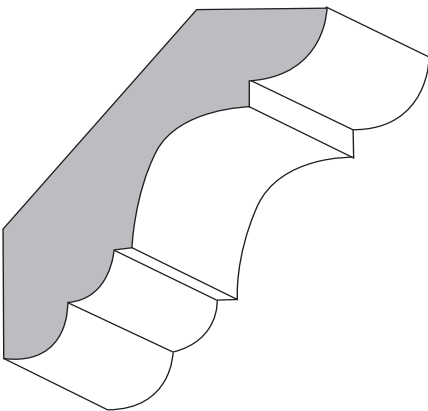

S3392
5/8 x 2 1/2

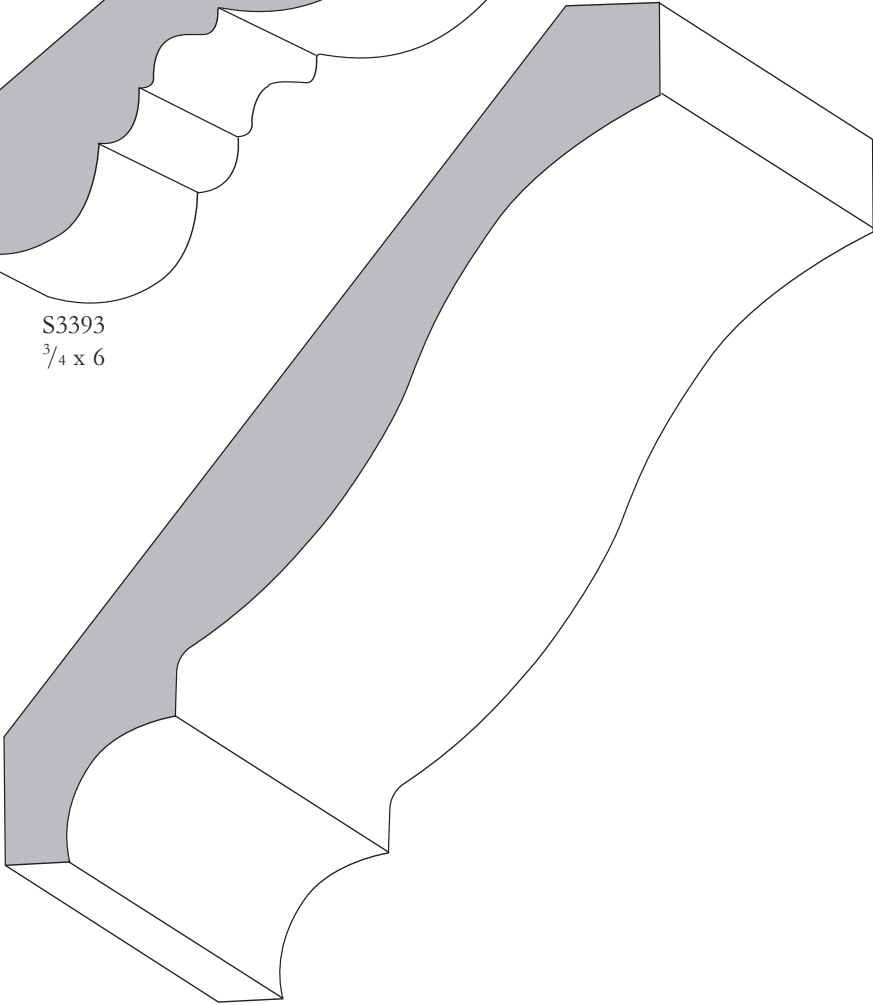

SK901
1 1/16 X 5 5/8



CROWN

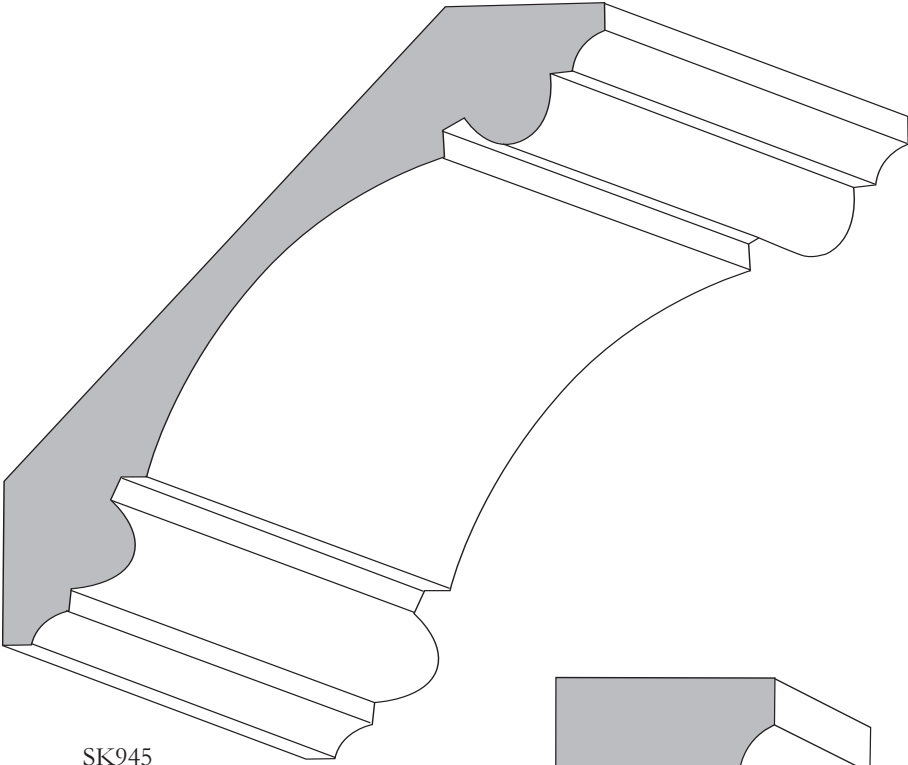

SK945
 $1\frac{3}{16} \times 4\frac{5}{8}$

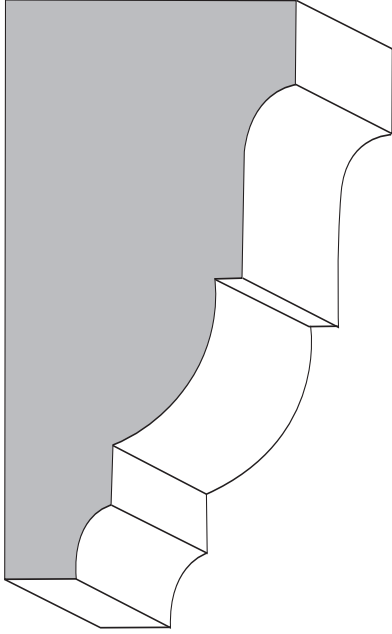

S5560
 $1\frac{1}{2} \times 3\frac{1}{16}$

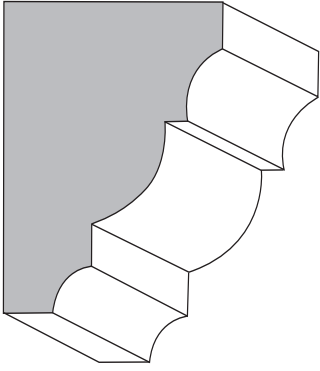

S5559
 $1\frac{1}{8} \times 1\frac{5}{8}$

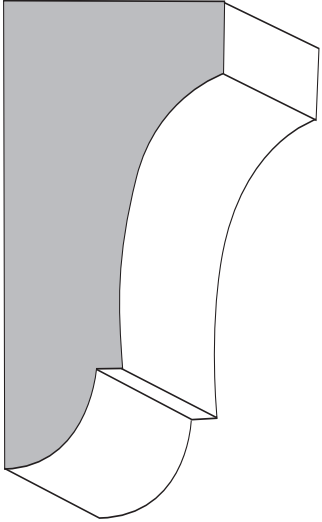

S5558
 $1\frac{1}{8} \times 2\frac{1}{2}$

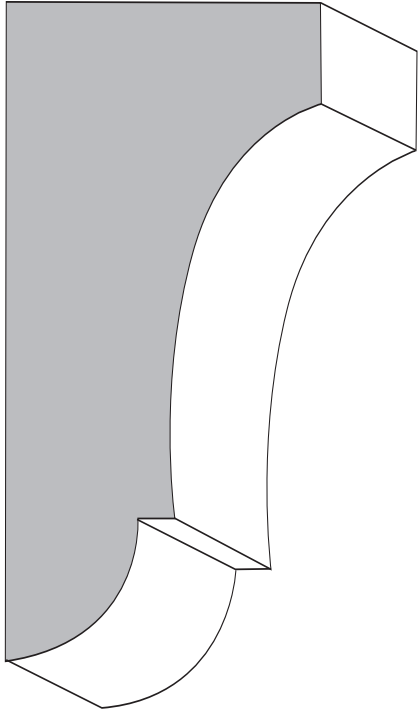

S5561
 $1\frac{5}{8} \times 3\frac{7}{16}$



CROWN

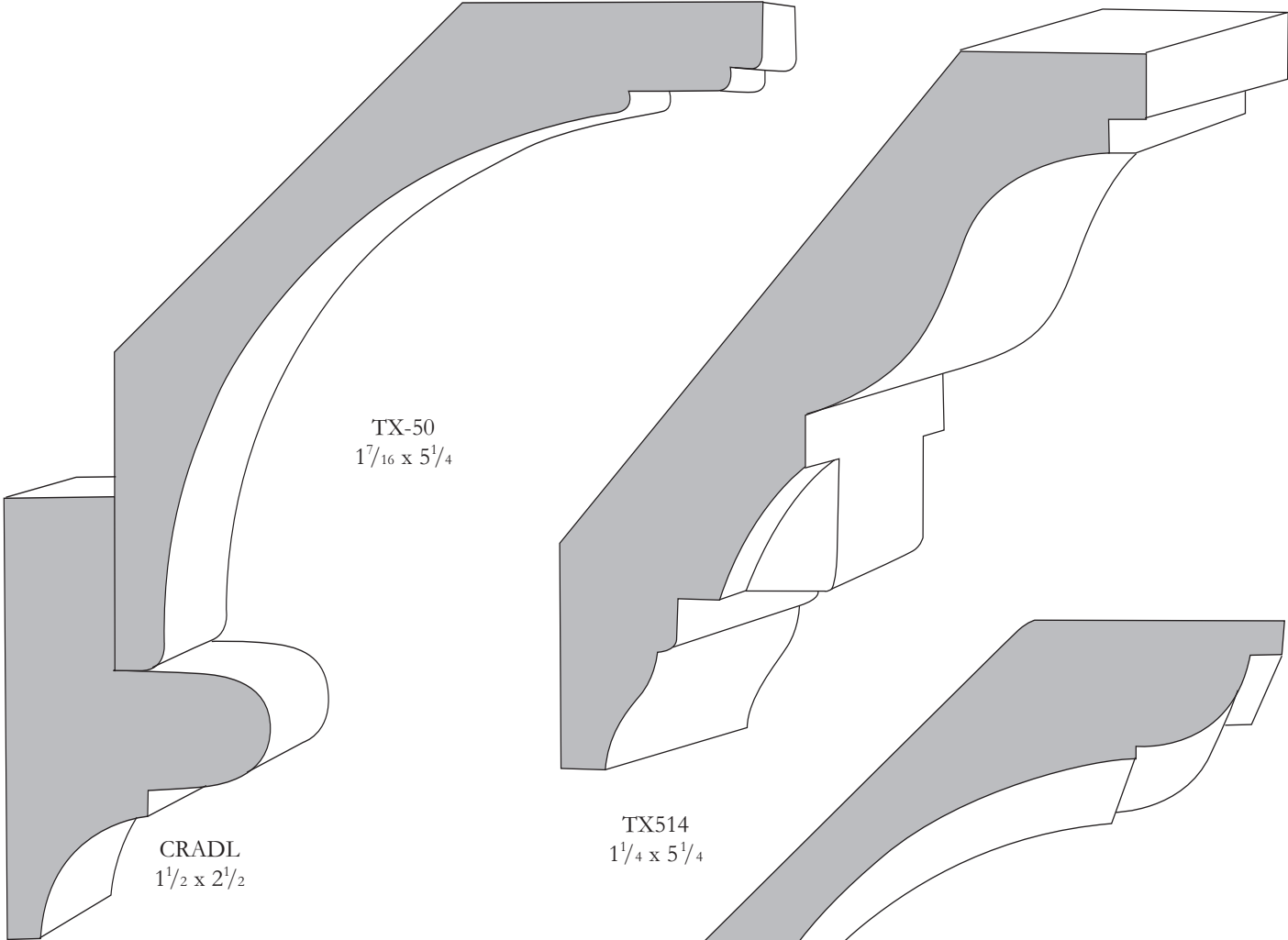

BASE

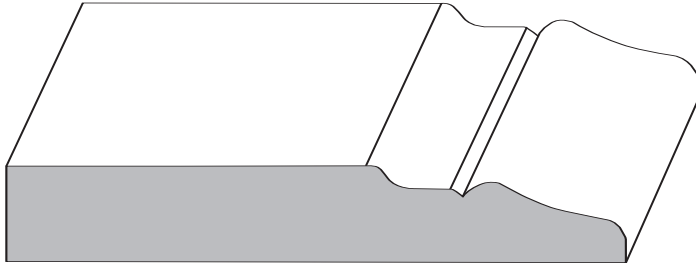

BBASE
 $\frac{1}{2} \times 3\frac{1}{4}$



CO623-H
 $\frac{1}{2} \times 3\frac{1}{4}$

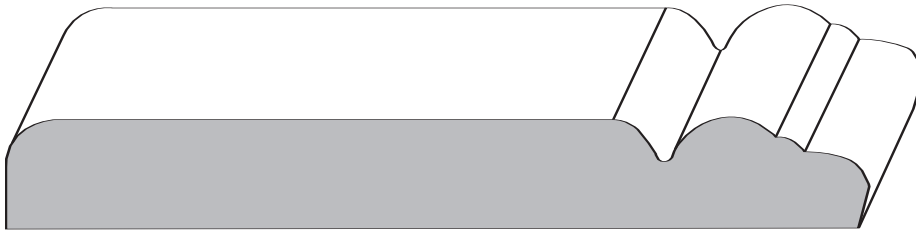

DB395
 $\frac{9}{16} \times 4\frac{1}{2}$

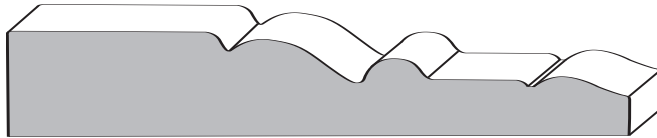

DB211
 $\frac{9}{16} \times 3\frac{1}{4}$

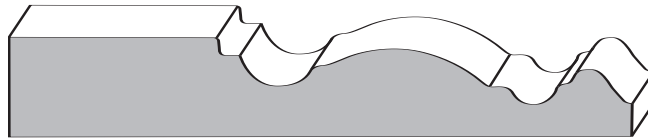

DB322
 $\frac{9}{16} \times 3\frac{1}{4}$

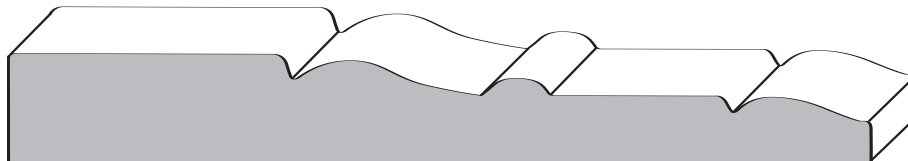

DLB11
 $\frac{9}{16} \times 4\frac{1}{2}$



BASE

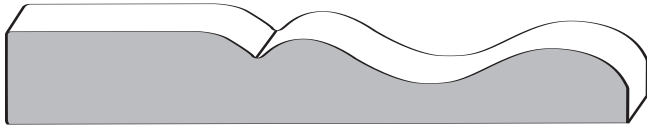

DWBA8
"A" Colonial Base
 $\frac{9}{16} \times 3\frac{1}{4}$

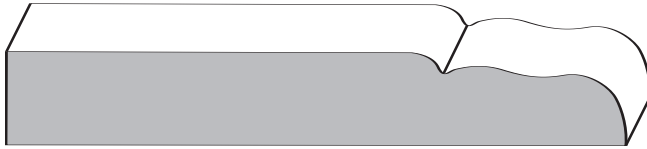

DW-B9
 $\frac{9}{16} \times 3\frac{1}{4}$

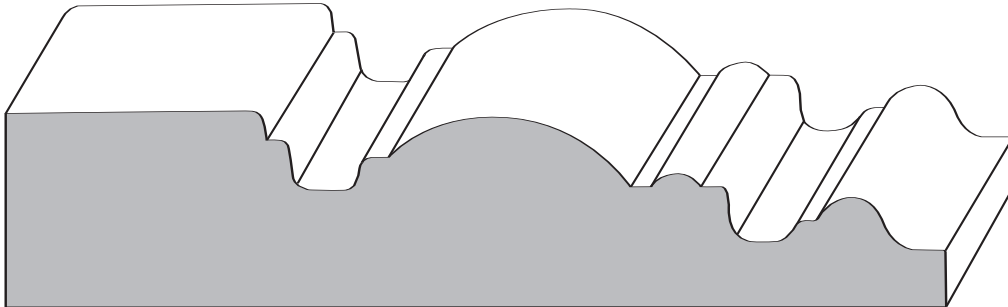

DWB22
 $1 \times 4\frac{7}{8}$

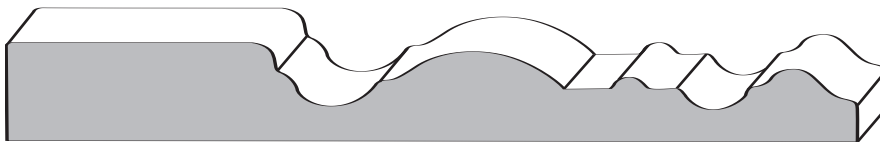

DWB522
 $\frac{9}{16} \times 4\frac{1}{2}$

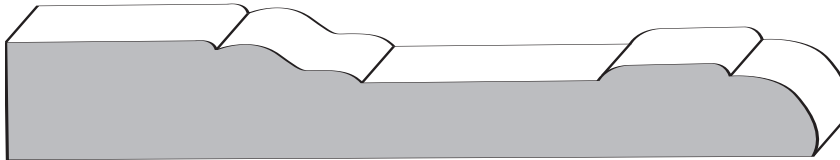

EL118-U
 $\frac{9}{16} \times 4\frac{1}{4}$



EL310-U
 $\frac{7}{16} \times 2\frac{1}{2}$



BASE



EL311-U
 $\frac{3}{8} \times 3\frac{1}{2}$



EL313-U
 $\frac{7}{16} \times 3\frac{7}{8}$



EL314-U
 $\frac{9}{16} \times 3\frac{1}{4}$

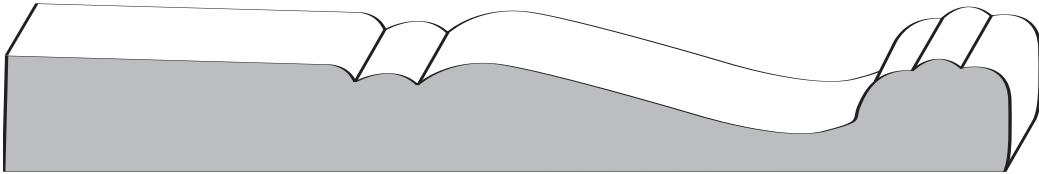

EL318-B
 $\frac{9}{16} \times 5\frac{1}{4}$

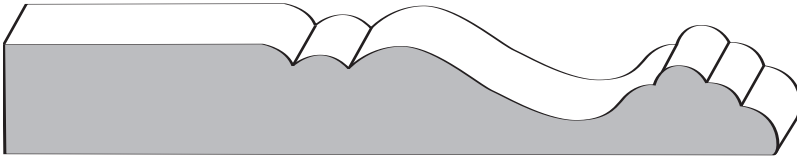

EL318-U
 $\frac{9}{16} \times 4$

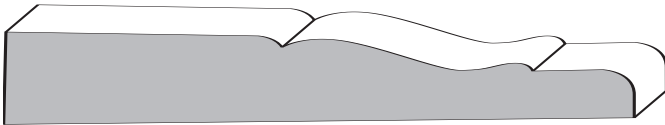

EL320-U
 $\frac{1}{2} \times 3\frac{1}{4}$

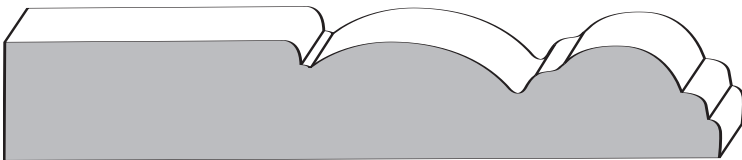

EL324-U
 $\frac{9}{16} \times 3\frac{3}{4}$

BASE

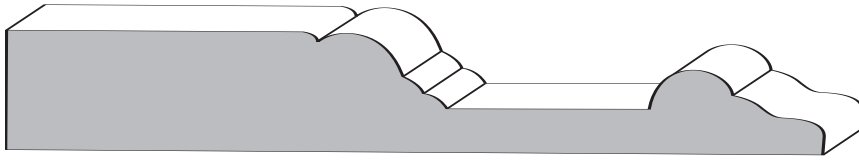

EL326-U
 $\frac{5}{8} \times 4\frac{1}{4}$

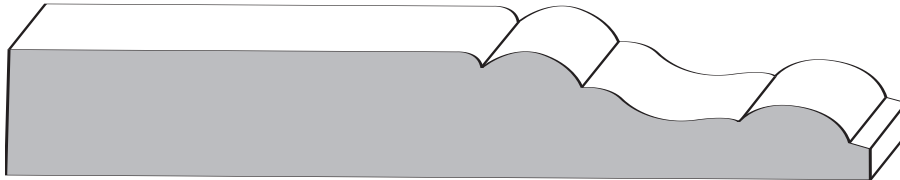

EL327-U
 $\frac{9}{16} \times 4\frac{1}{2}$

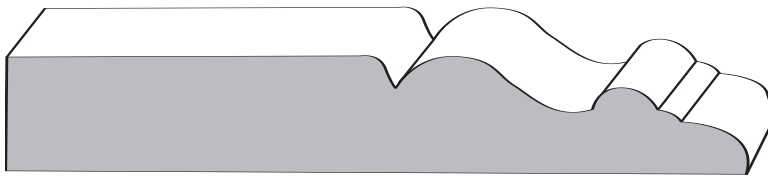

EL329-U
 $\frac{9}{16} \times 3\frac{7}{8}$



EL330-U
 $\frac{9}{16} \times 5$

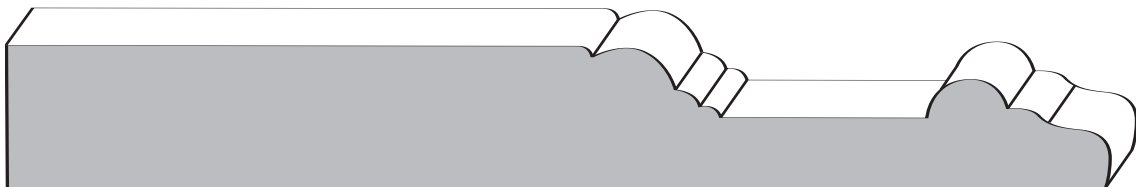

EL332-U
 $\frac{3}{4} \times 5\frac{3}{4}$

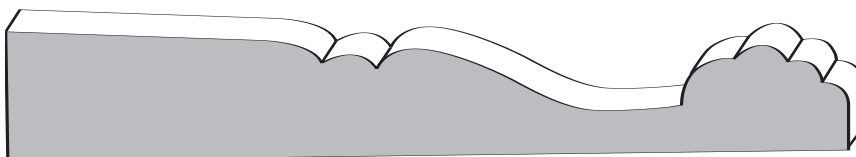

HO402
 $\frac{11}{16} \times 4\frac{3}{8}$



BASE

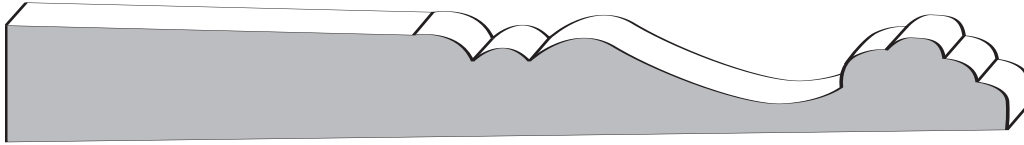

HO403
 $\frac{11}{16} \times 5\frac{1}{4}$

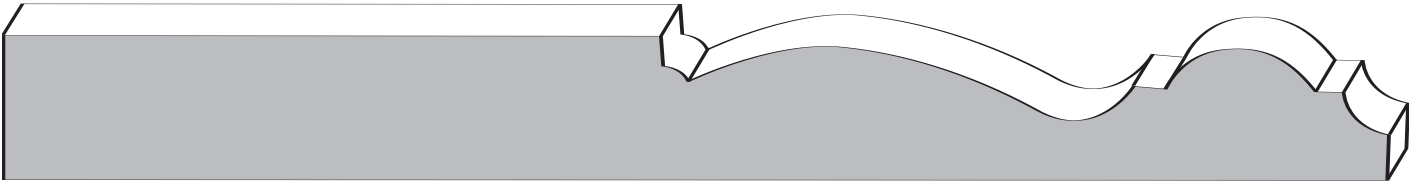

HO405
 $\frac{11}{16} \times 7\frac{1}{4}$

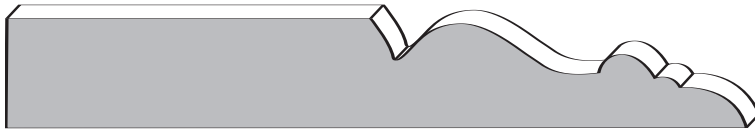

HO441-M
 $\frac{9}{16} \times 3\frac{7}{8}$

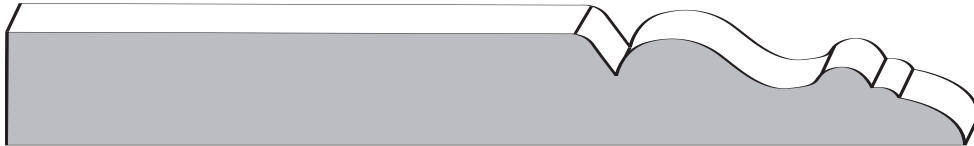

HO442-M
 $\frac{9}{16} \times 5$

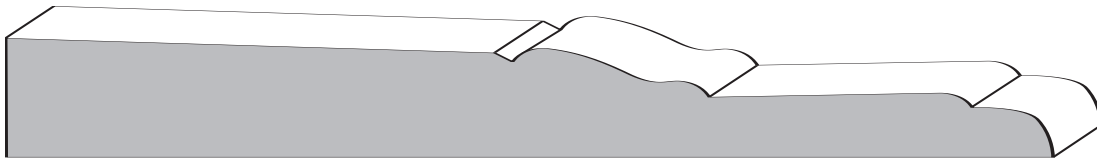

HO655
 $\frac{5}{8} \times 5\frac{1}{2}$

BASE

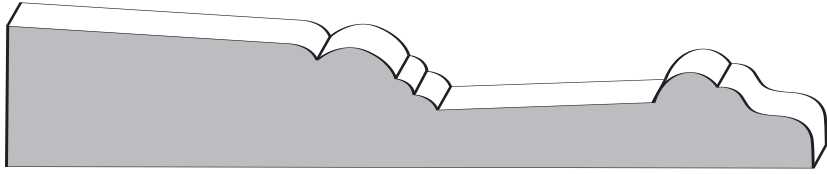

HO656
 $1\frac{1}{16} \times 4\frac{1}{4}$



KE004
 $\frac{9}{16} \times 5\frac{7}{16}$

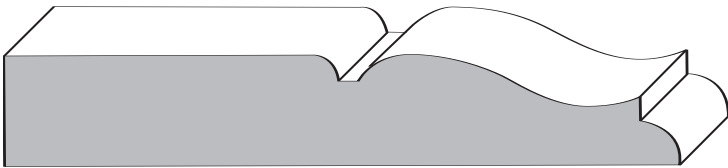

KE015
 $\frac{9}{16} \times 3\frac{7}{16}$

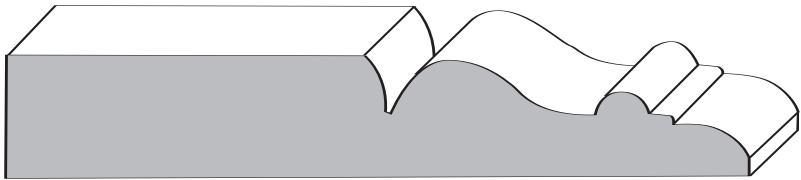

KE-20-M
 $\frac{5}{8} \times 3\frac{7}{8}$



KE-121-M
 $\frac{9}{16} \times 7\frac{1}{4}$



KE-28-M
 $\frac{5}{8} \times 6\frac{1}{8}$



BASE

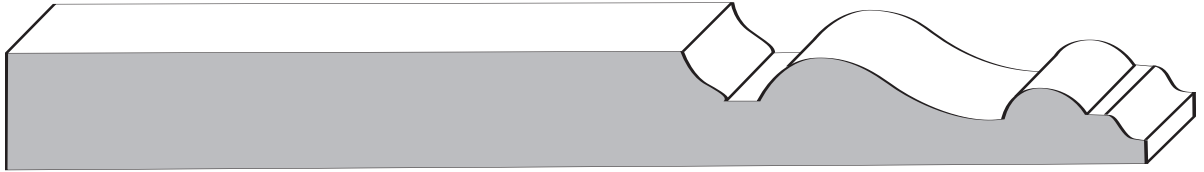

KE-24-M
 $\frac{9}{16} \times 6$



KE029-M
 $\frac{9}{16} \times 5\frac{1}{4}$

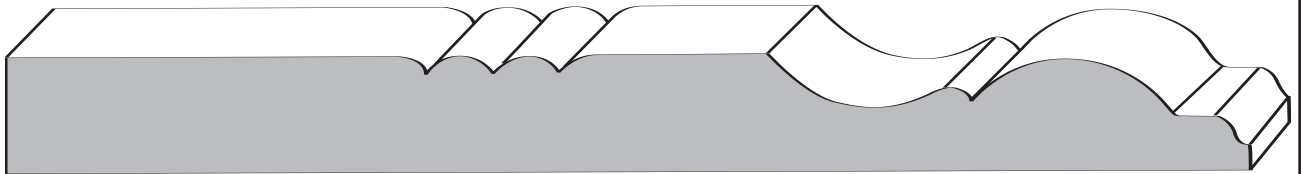

KE-30-M
 $\frac{9}{16} \times 6\frac{1}{2}$

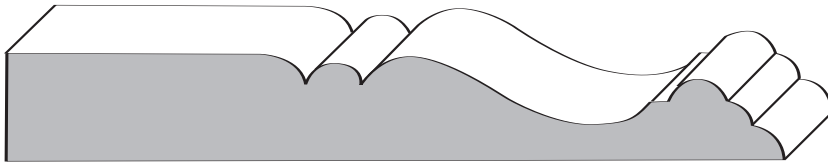

KE-83-M
 $\frac{9}{16} \times 4$

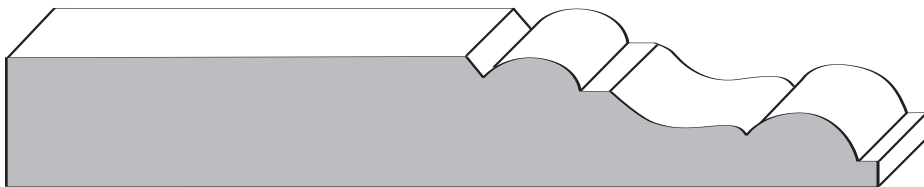

KE-84-M
 $\frac{9}{16} \times 4\frac{1}{2}$

BASE



KE112
 $\frac{9}{16} \times 5\frac{1}{4}$



KE112-M
 $\frac{9}{16} \times 5\frac{7}{16}$



KE114-M
 $\frac{9}{16} \times 5\frac{1}{4}$

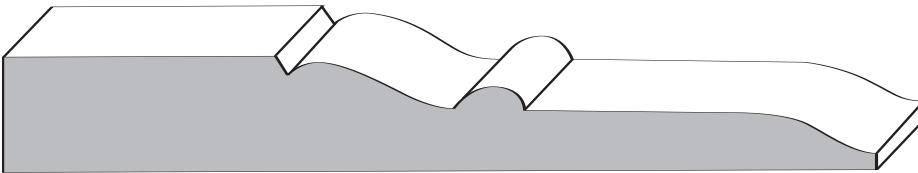

KE118-M
 $\frac{9}{16} \times 4\frac{9}{16}$



KE120-M
 $\frac{9}{16} \times 5\frac{1}{4}$



BASE

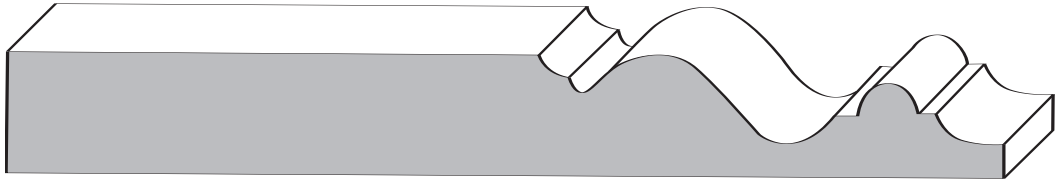

KE182
 $1\frac{1}{16} \times 5\frac{1}{4}$

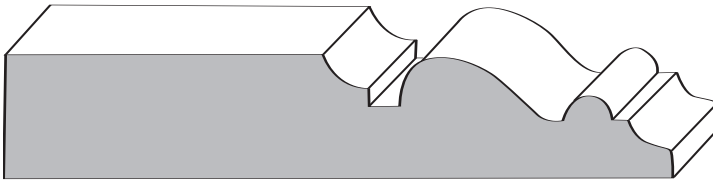

KE203-M KE203-P
 $\frac{9}{16} \times 3\frac{7}{16}$ $\frac{9}{16} \times 3\frac{7}{16}$

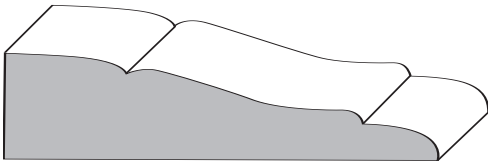

KE205
 $1\frac{1}{16} \times 2\frac{1}{4}$



KE206
 $\frac{1}{2} \times 5\frac{1}{2}$

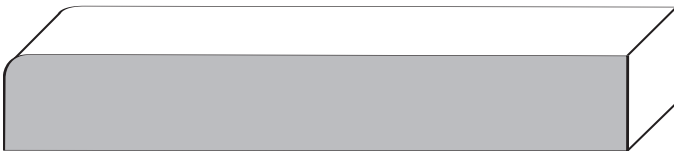

KE210
 $\frac{1}{2} \times 3\frac{1}{4}$

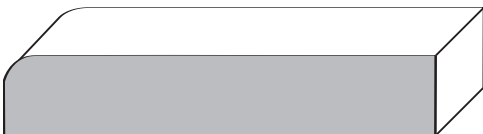

KE212-M EL304-R
 $\frac{3}{8} \times 2\frac{1}{4}$ $\frac{3}{8} \times 2\frac{1}{4}$

BASE

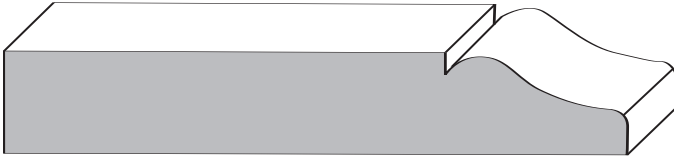

KE213
 $\frac{9}{16} \times 3\frac{1}{4}$



KE215
 $\frac{1}{2} \times 5\frac{1}{4}$



KE217-M
 $\frac{9}{16} \times 5\frac{1}{4}$

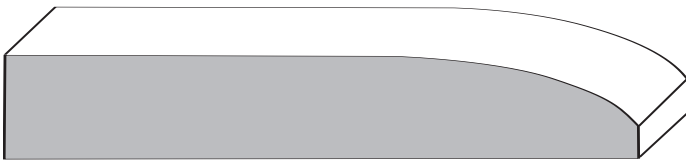

KE220
 $\frac{1}{2} \times 3\frac{1}{4}$



KE221-N
 $\frac{9}{16} \times 3\frac{1}{4}$

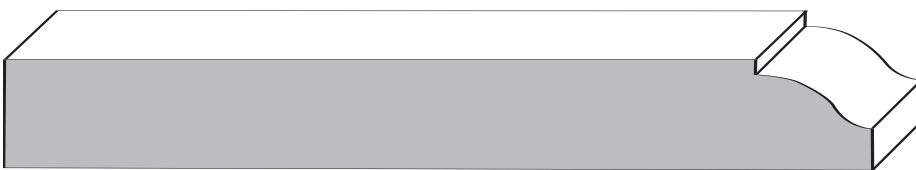

KE222-M
 $\frac{9}{16} \times 4\frac{1}{2}$

KE222
 $\frac{9}{16} \times 4\frac{1}{2}$



BASE



KE223-M
 $\frac{9}{16} \times 5\frac{1}{4}$

KE223-P
 $\frac{9}{16} \times 5\frac{1}{4}$

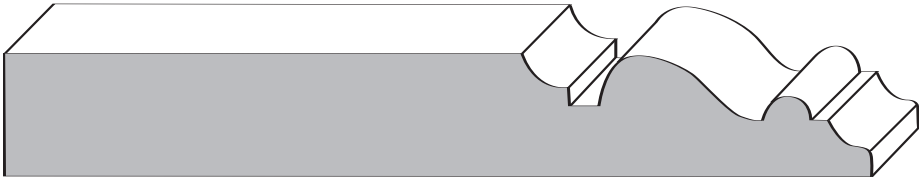

KE233-M
 $\frac{9}{16} \times 4\frac{1}{2}$

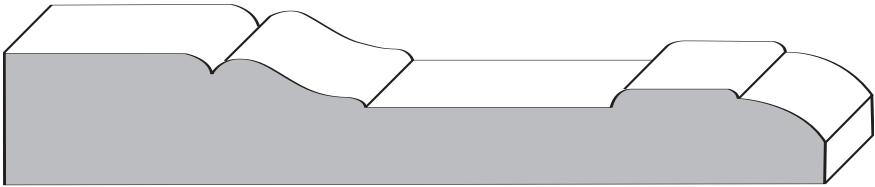

KE416
 $\frac{11}{16} \times 4\frac{1}{4}$



KE-26-M
 $\frac{9}{16} \times 5\frac{1}{4}$



KE114-M
 $\frac{9}{16} \times 5\frac{1}{4}$

BASE

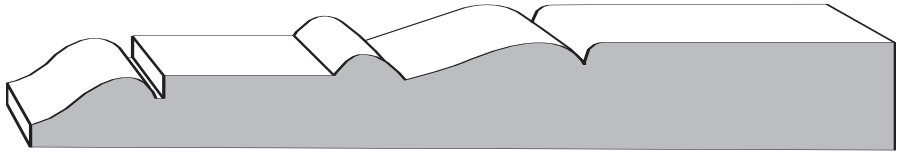

LB-12
 $\frac{9}{16} \times 4\frac{1}{2}$

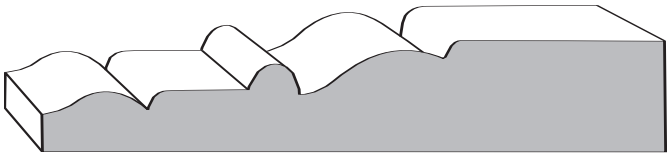

LB211
 $\frac{9}{16} \times 3\frac{1}{4}$

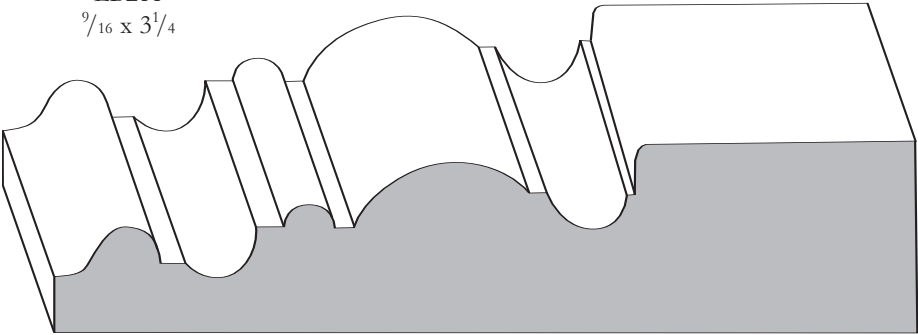

LB422
 $1 \times 4\frac{1}{2}$

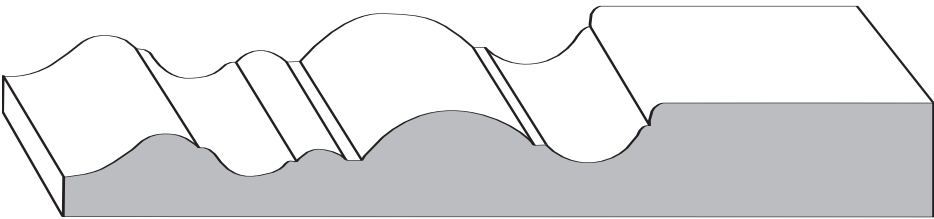

LB522
 $\frac{9}{16} \times 4\frac{1}{2}$



LB618
 $\frac{9}{16} \times 5\frac{1}{4}$



BASE

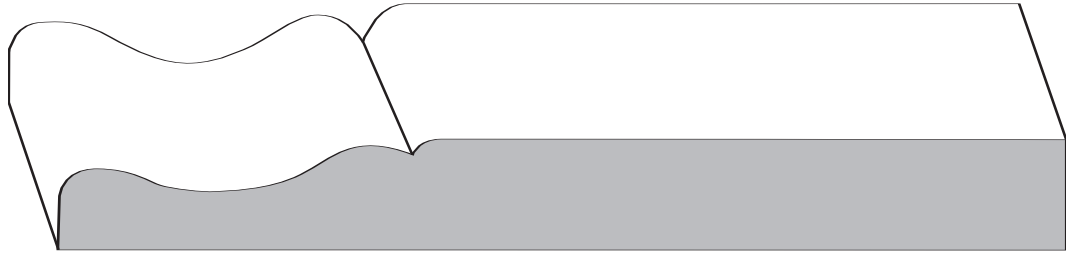

LH-B9
 $\frac{9}{16} \times 5\frac{1}{4}$

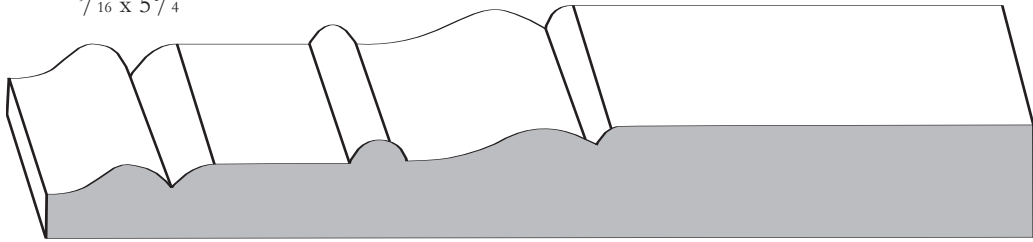

LHB11-A
 $\frac{1}{2} \times 5\frac{1}{8}$



LHB21
 $\frac{1}{2} \times 5\frac{3}{8}$

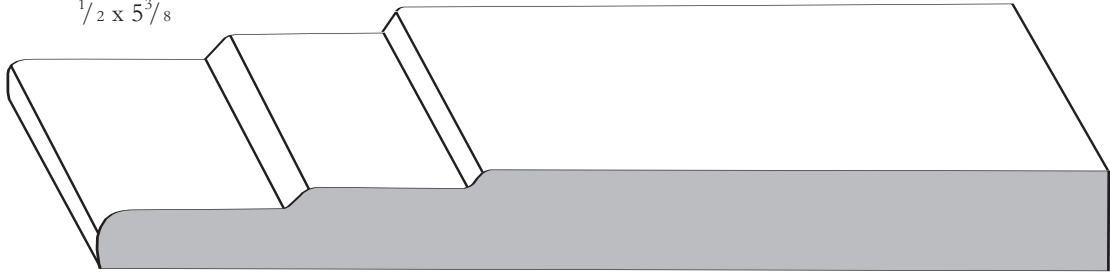

LHB-C
 $\frac{1}{2} \times 5\frac{1}{2}$



LB695
 $\frac{9}{16} \times 6\frac{1}{2}$

BASE



LB633
 $\frac{1}{2} \times 3\frac{1}{4}$

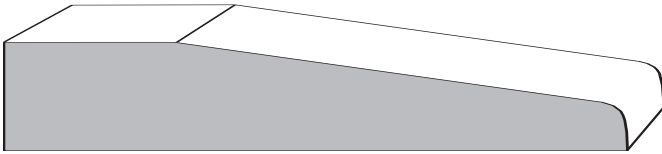

LS-B2
 $\frac{9}{16} \times 3\frac{1}{4}$

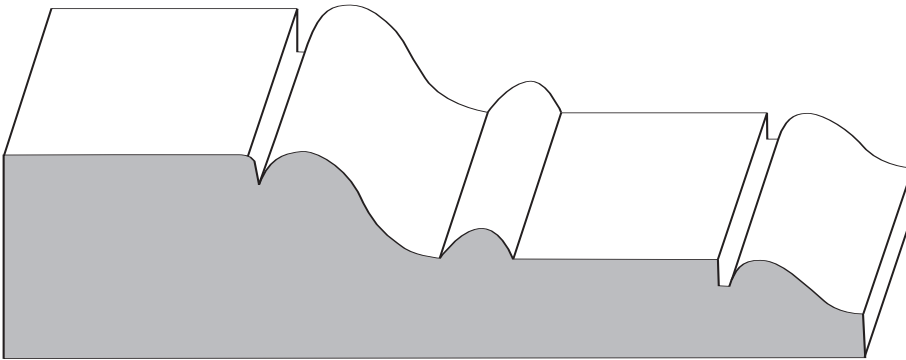

LSB11
 $1\frac{1}{16} \times 4\frac{1}{2}$

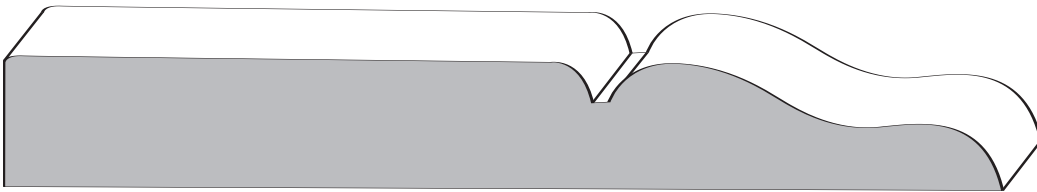

OR514-B
 $\frac{11}{16} \times 5\frac{1}{4}$

KE217
 $\frac{11}{16} \times 5\frac{1}{4}$



OR211
 $\frac{11}{16} \times 5\frac{3}{16}$

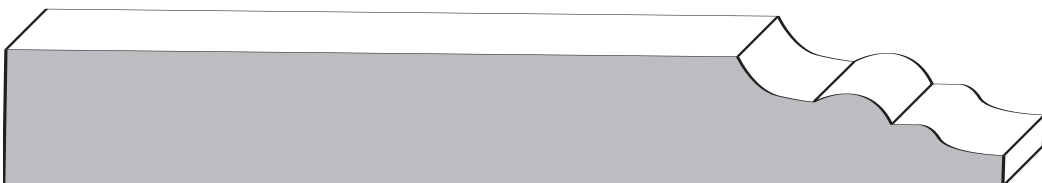

OR514-R
 $\frac{9}{16} \times 5\frac{1}{4}$

KE215
 $\frac{9}{16} \times 5\frac{1}{4}$



BASE

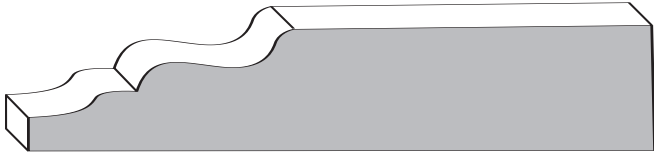

OR210
 $\frac{5}{8} \times 3\frac{1}{4}$

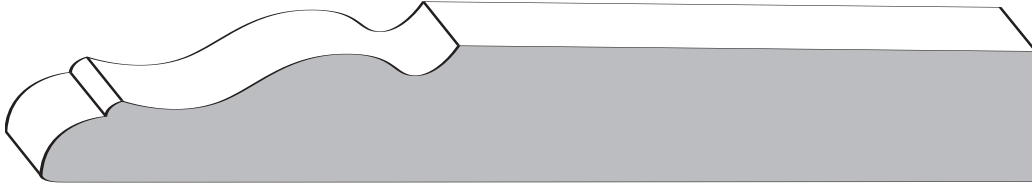

OR514-V
 $\frac{11}{16} \times 5\frac{1}{4}$



KE-208
 $\frac{1}{2} \times 2\frac{1}{4}$



S2201
 $\frac{3}{8} \times 2\frac{1}{4}$



S2202
 $\frac{3}{8} \times 3\frac{1}{4}$

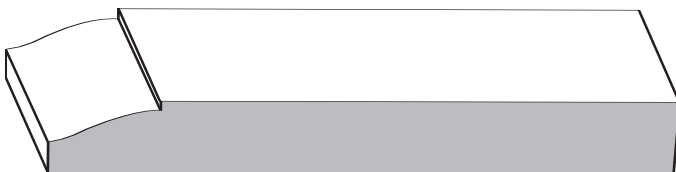

S2203
 $\frac{3}{8} \times 3\frac{1}{4}$

BASE



S2204
 $\frac{9}{16} \times 3 \frac{3}{8}$

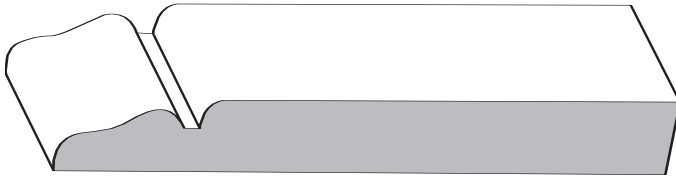

S2205
 $\frac{3}{8} \times 3 \frac{3}{8}$



S2206
 $\frac{9}{16} \times 3 \frac{3}{8}$



S2207
 $\frac{9}{16} \times 5 \frac{1}{4}$



S2208
 $\frac{9}{16} \times 5 \frac{1}{4}$

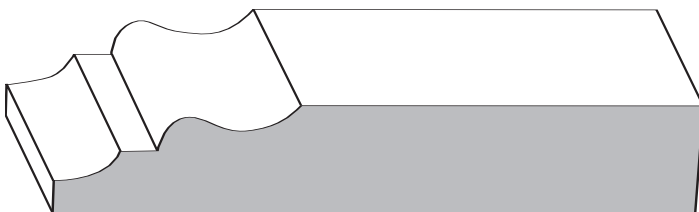

S2210
 $\frac{9}{16} \times 3 \frac{3}{8}$



BASE



S2211
 $\frac{9}{16} \times 5 \frac{1}{4}$

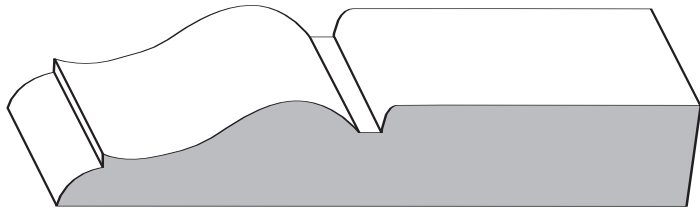

S2213
 $\frac{9}{16} \times 3 \frac{3}{8}$

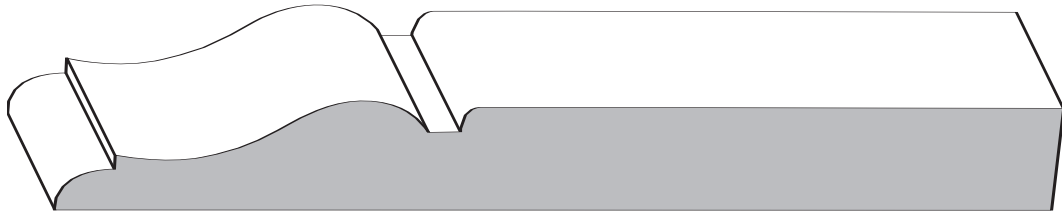

S2214
 $\frac{9}{16} \times 5 \frac{1}{4}$

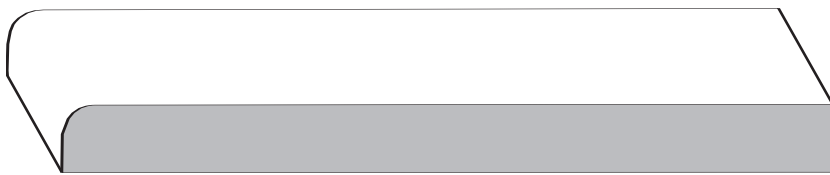

S2222
 $\frac{3}{8} \times 4$

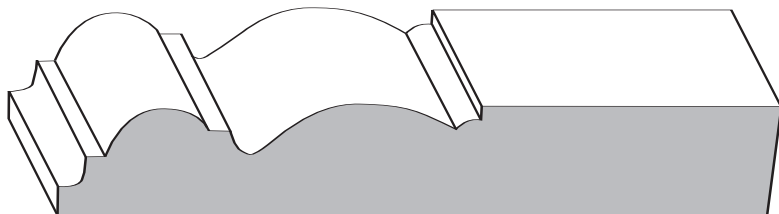

S2223
 $\frac{9}{16} \times 3 \frac{3}{4}$



BASE

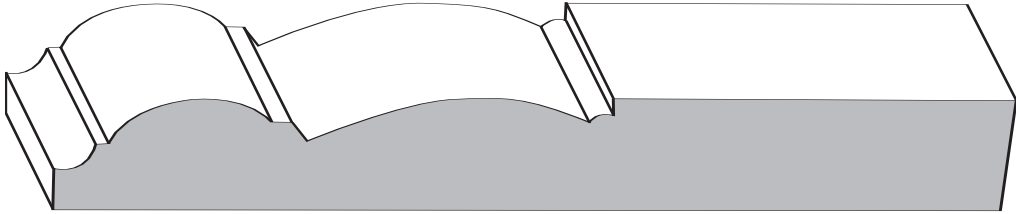

S2224
 $\frac{9}{16} \times 5$

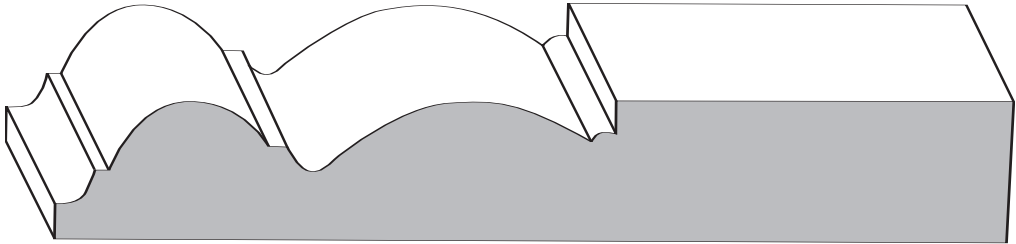

S2226
 $\frac{3}{4} \times 5$

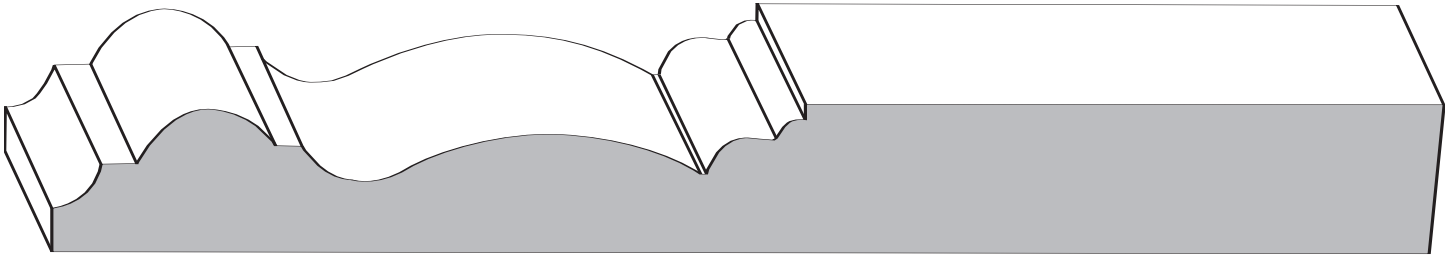

S2227
 $\frac{3}{4} \times 7 \frac{1}{4}$

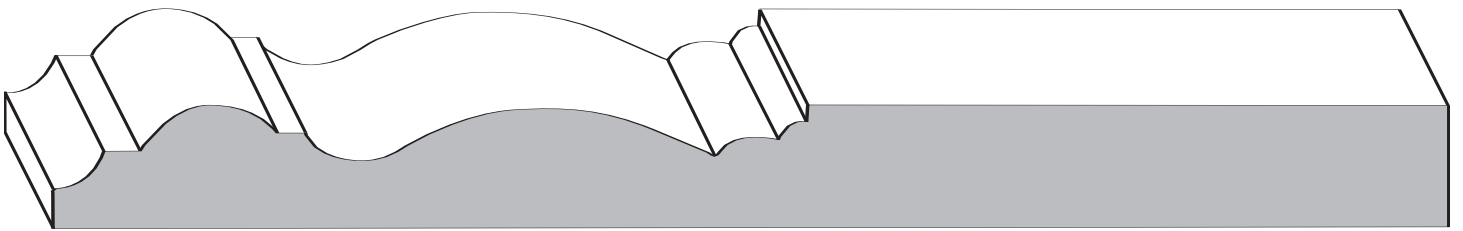

S2228
 $\frac{5}{8} \times 7 \frac{1}{4}$

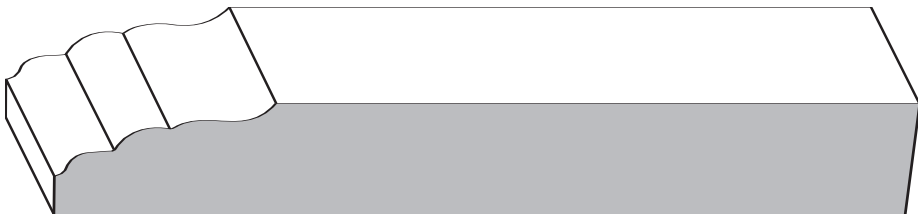

S2229
 $\frac{9}{16} \times 4 \frac{1}{2}$



BASE

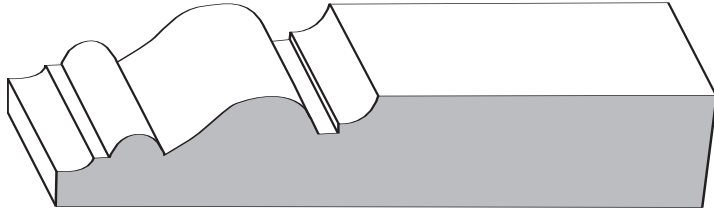

S2230
 $\frac{9}{16} \times 3 \frac{3}{8}$

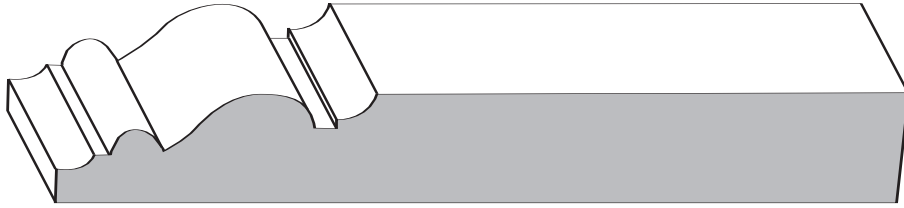

S2231
 $\frac{9}{16} \times 4 \frac{3}{8}$

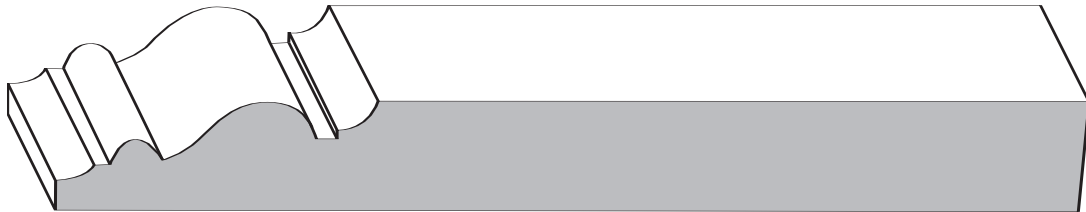

S2232
 $\frac{9}{16} \times 5 \frac{3}{8}$

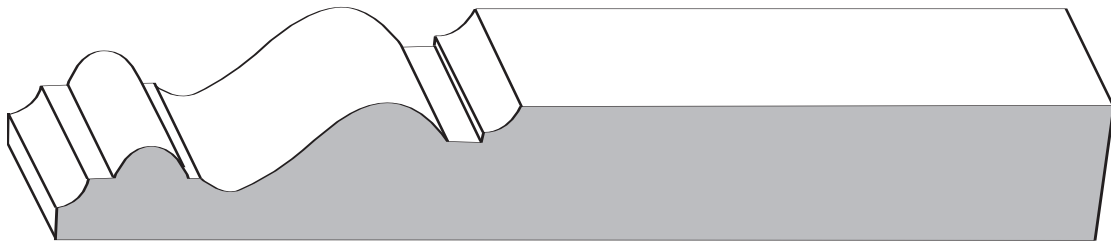

S2235
 $\frac{11}{16} \times 5 \frac{1}{2}$

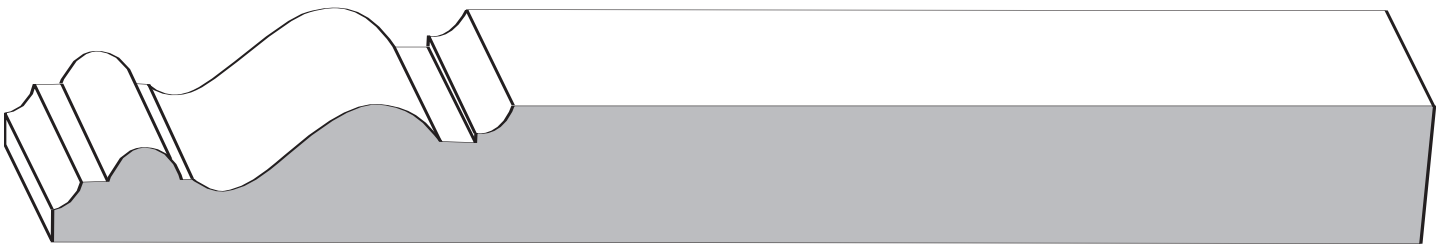

S2236
 $\frac{11}{16} \times 7 \frac{3}{16}$



BASE

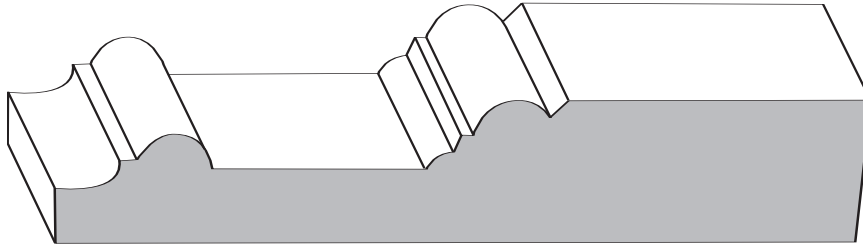

S2237
 $\frac{3}{4} \times 4 \frac{1}{4}$

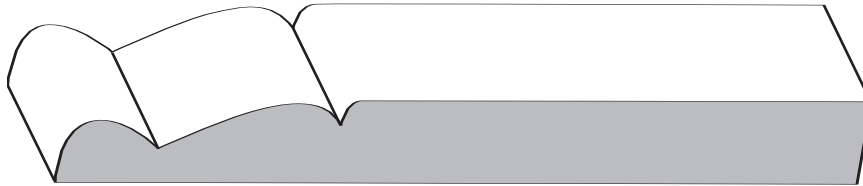

S2238
 $\frac{1}{2} \times 4 \frac{1}{4}$

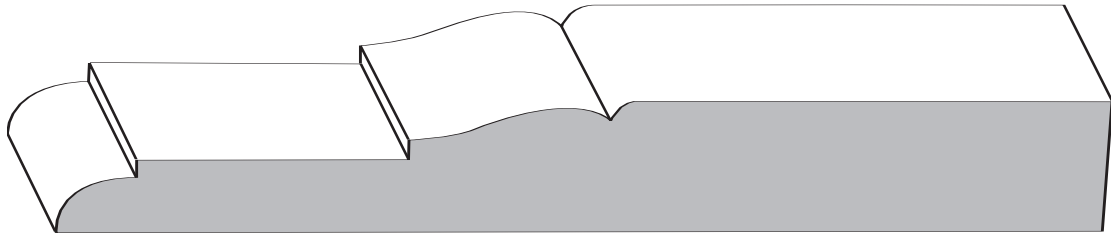

S2239
 $\frac{11}{16} \times 5 \frac{1}{2}$

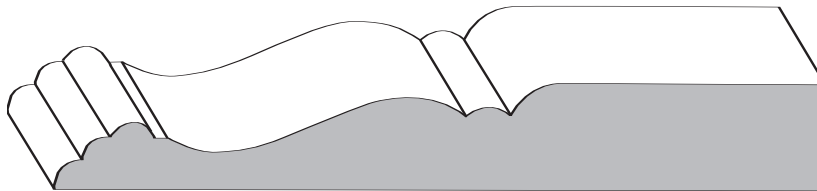

S2240
 $\frac{9}{16} \times 4$

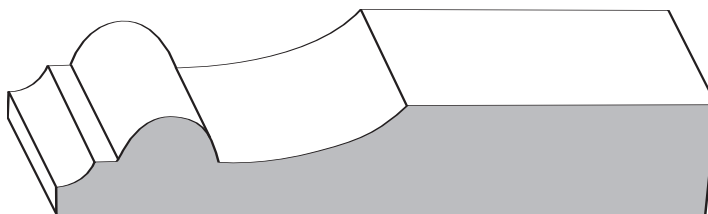

S2243
 $\frac{9}{16} \times 3 \frac{3}{8}$



BASE



S2244
 $\frac{9}{16} \times 5 \frac{1}{4}$

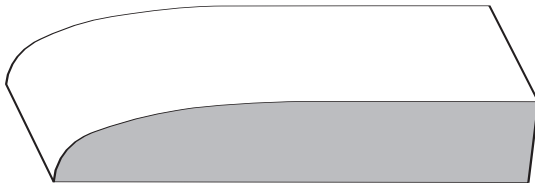

S2248
 $\frac{1}{2} \times 2 \frac{1}{2}$

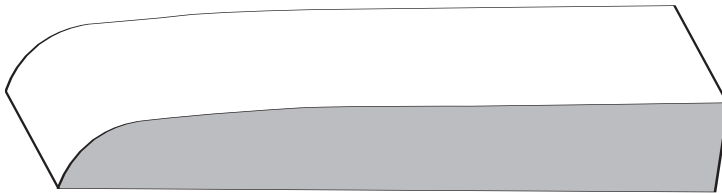

S2249
 $\frac{1}{2} \times 3 \frac{1}{2}$

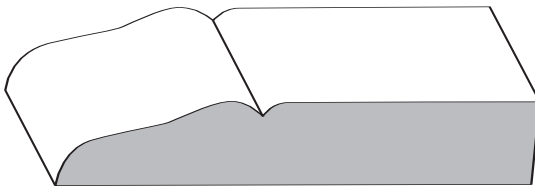

S2250
 $\frac{1}{2} \times 2 \frac{1}{2}$

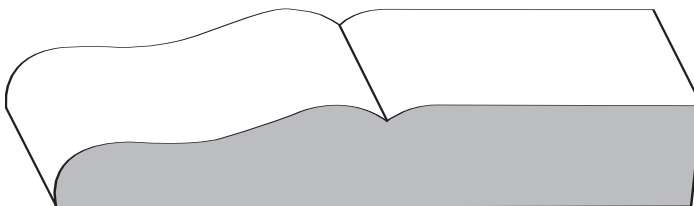

S2251
 $\frac{1}{2} \times 3 \frac{1}{2}$

BASE

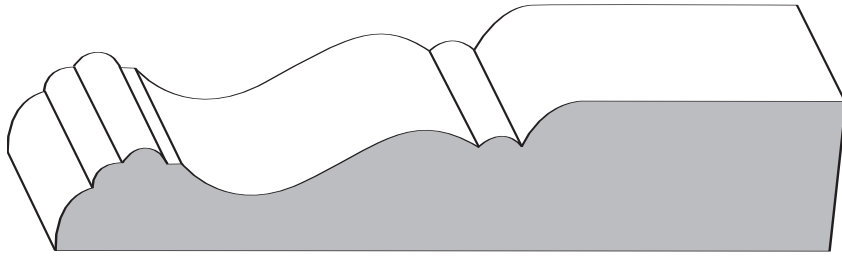

S2253
 $\frac{3}{4} \times 4$

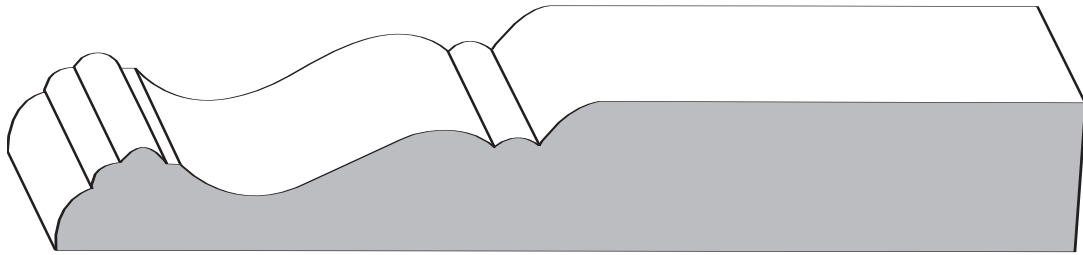

S2254
 $\frac{3}{4} \times 5 \frac{3}{8}$

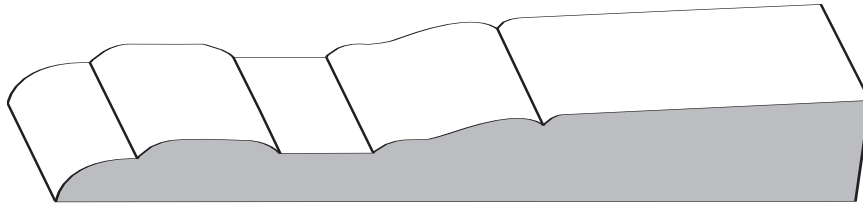

S2255
 $\frac{1}{2} \times 4 \frac{1}{4}$

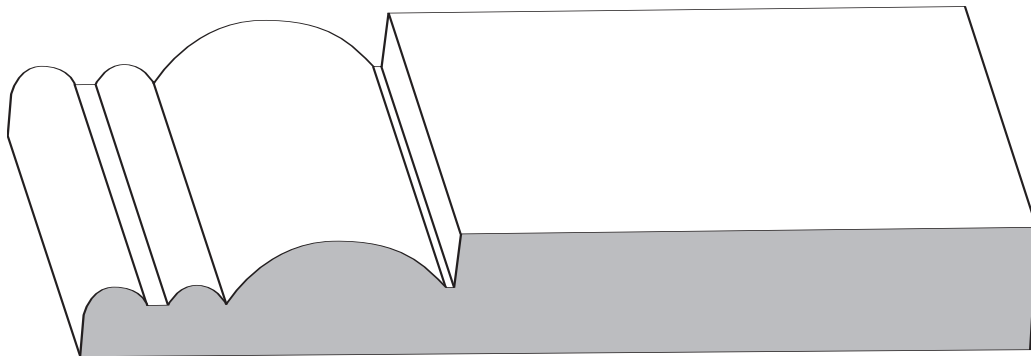

SK903-M
 $\frac{11}{16} \times 5$



BASE

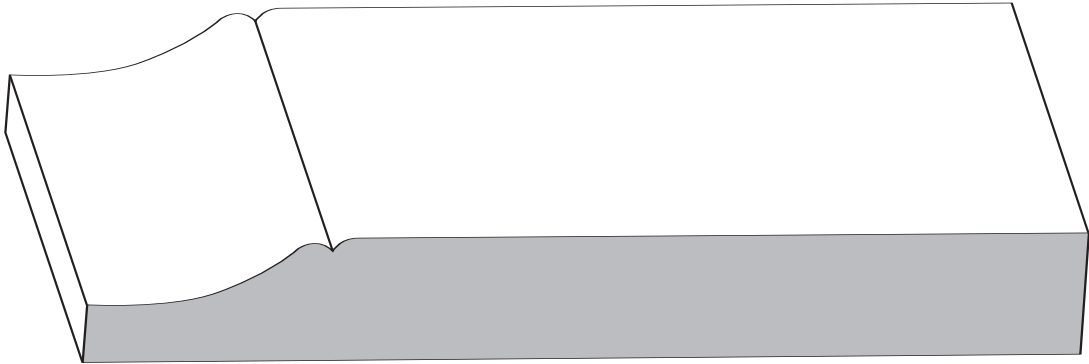

SK906
 $1\frac{1}{16} \times 5\frac{1}{4}$

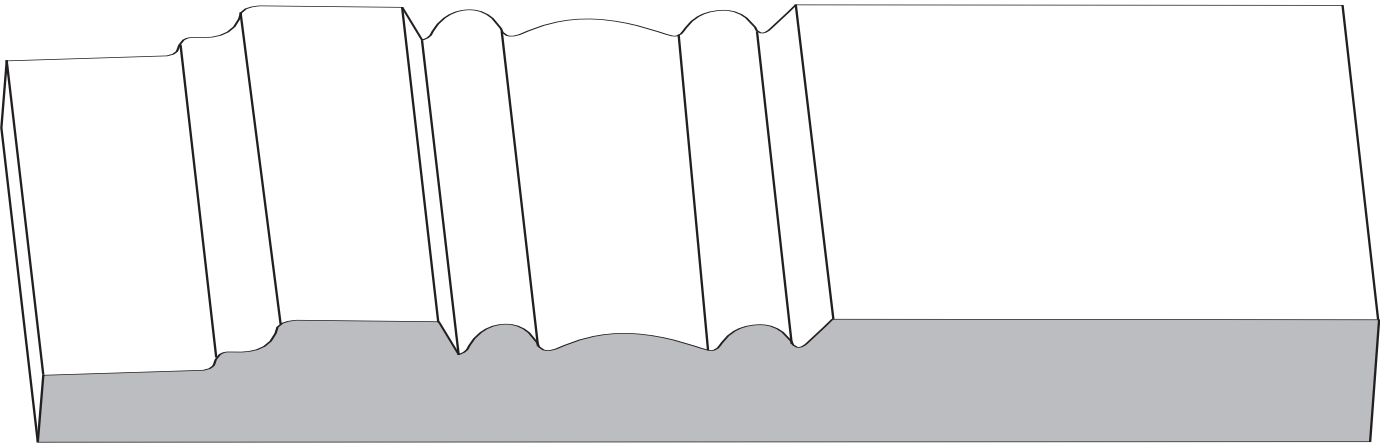

SK916
 $1\frac{1}{16} \times 7$
Victorian

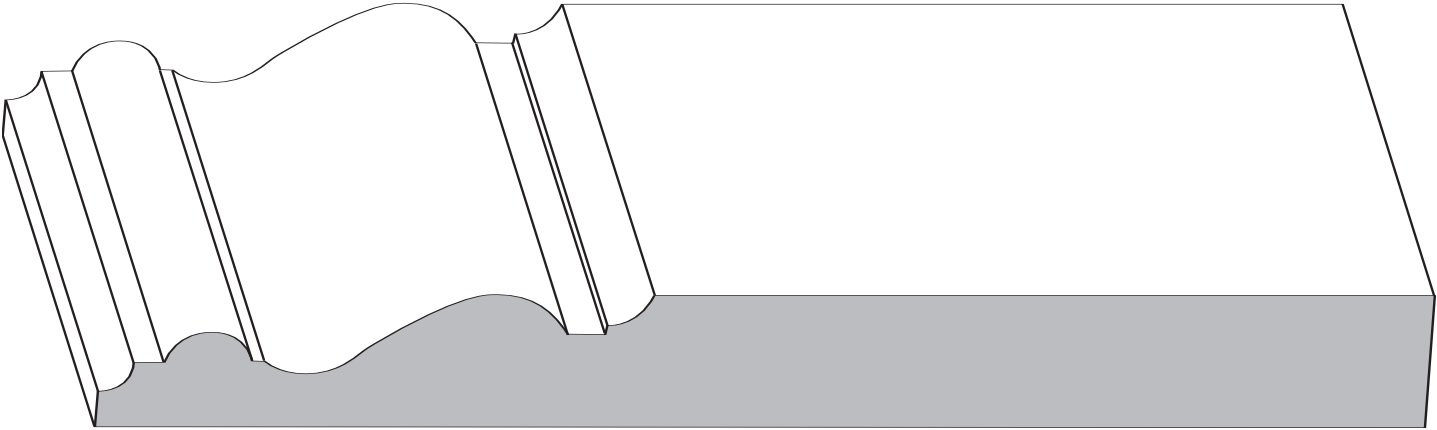

SK947
 $\frac{3}{4} \times 7$
Coors Base



BASE

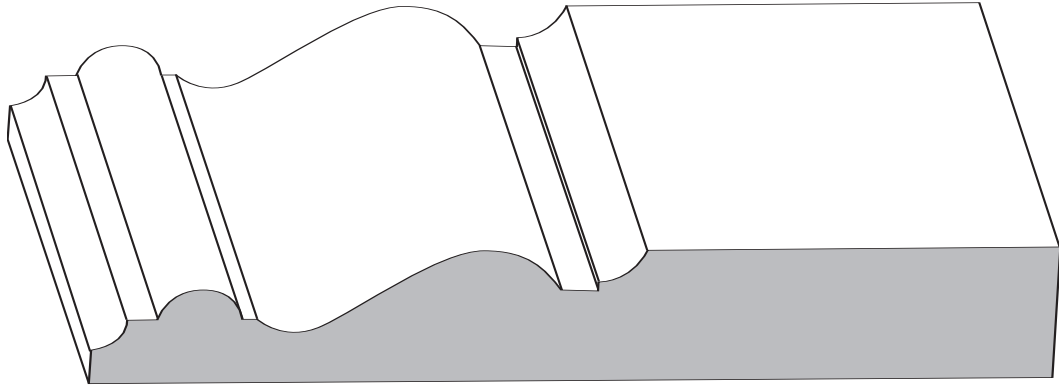

SK949
 $\frac{3}{4} \times 5$
Coors Base

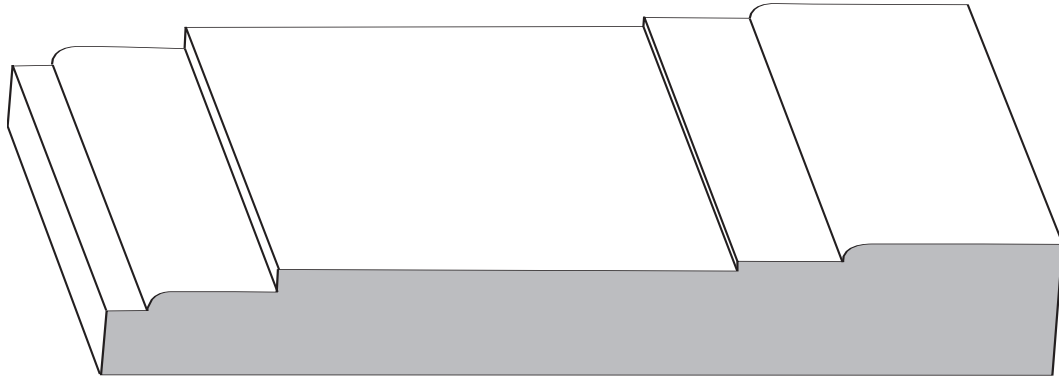

SK952
 $\frac{11}{16} \times 5$
Broadway Base

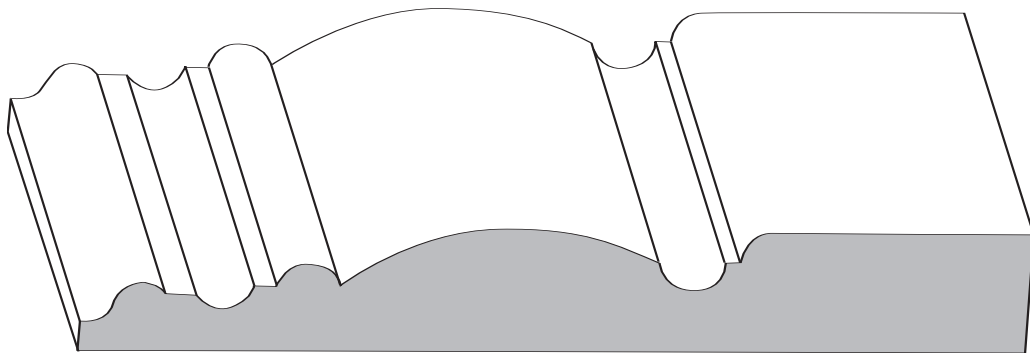

STARK-S
 $\frac{11}{16} \times 5$



BASE

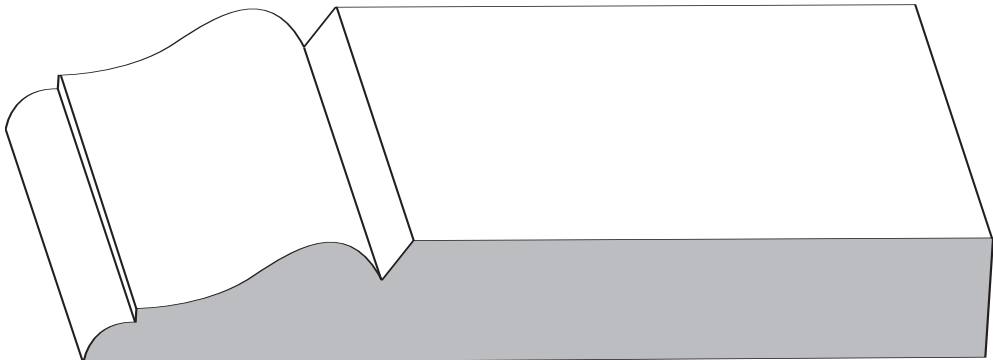

TABOR-M
 $\frac{11}{16} \times 4\frac{3}{4}$

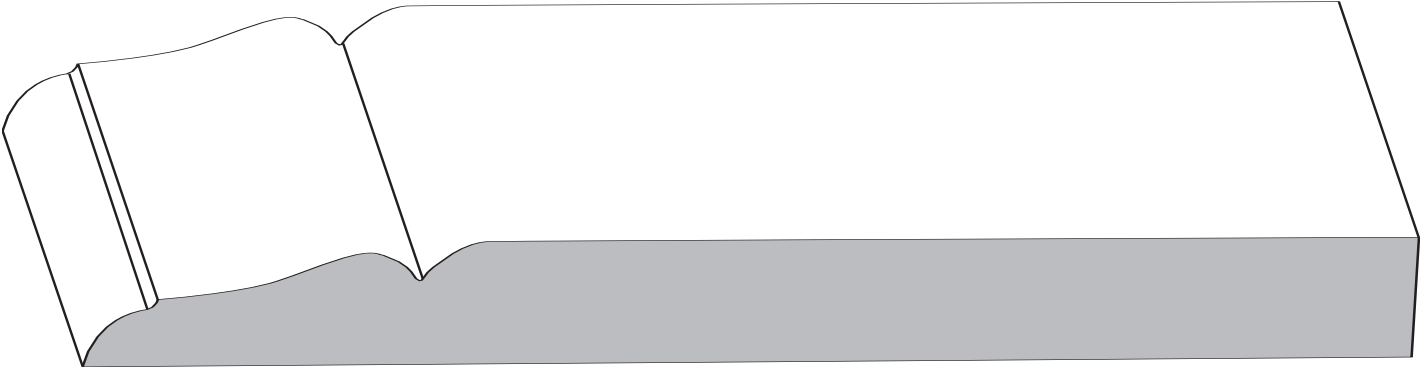

TABOR-S
 $\frac{11}{16} \times 7$

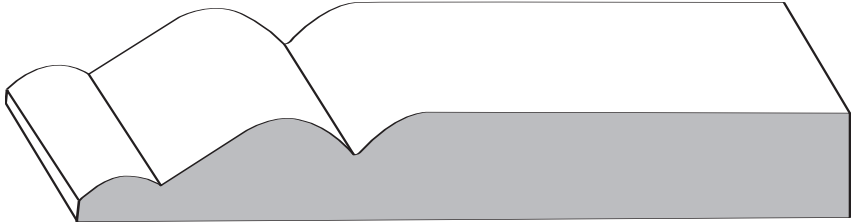

TB218
 $\frac{1}{2} \times 4$

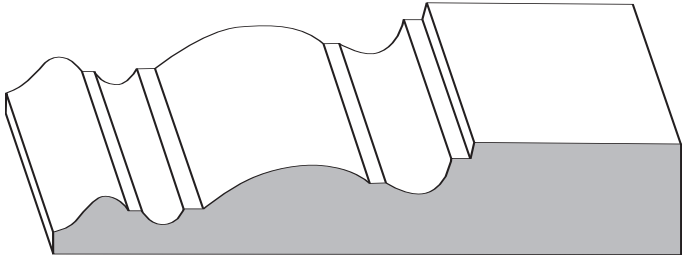

TB322
 $\frac{9}{16} \times 3\frac{1}{4}$



BASE

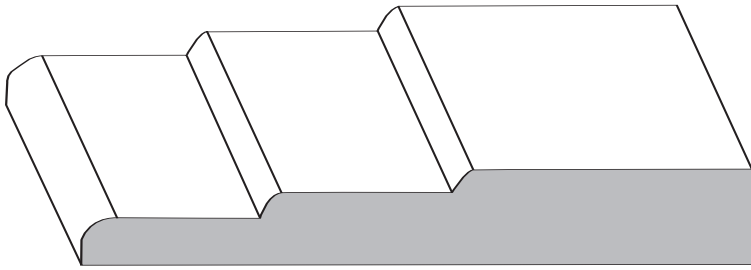

TCBS1
 $\frac{1}{2} \times 3\frac{1}{2}$

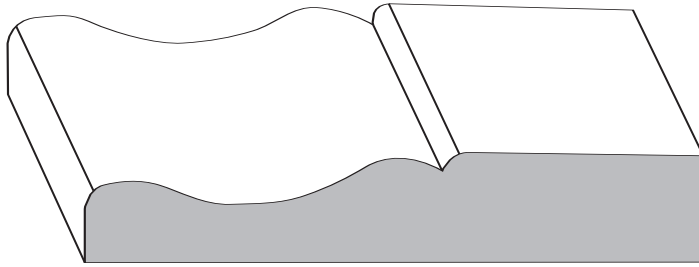

TX-B8
 $\frac{9}{16} \times 3\frac{1}{4}$



TXB20
 $\frac{1}{2} \times 3\frac{1}{4}$

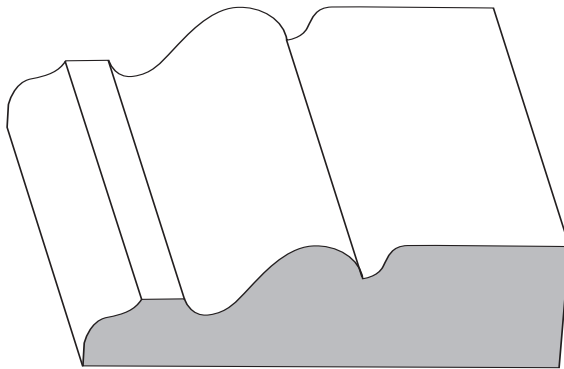

WM212-L
 $\frac{11}{16} \times 2\frac{1}{2}$



BASE

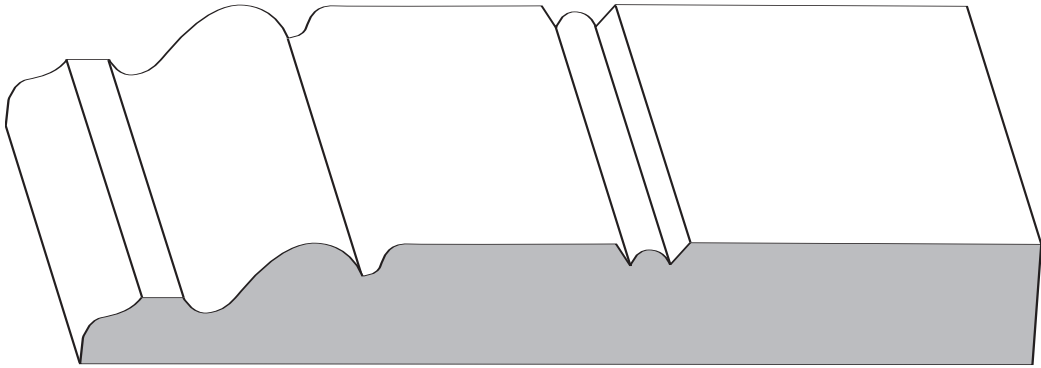

WM212-M
 $1\frac{1}{16} \times 5$

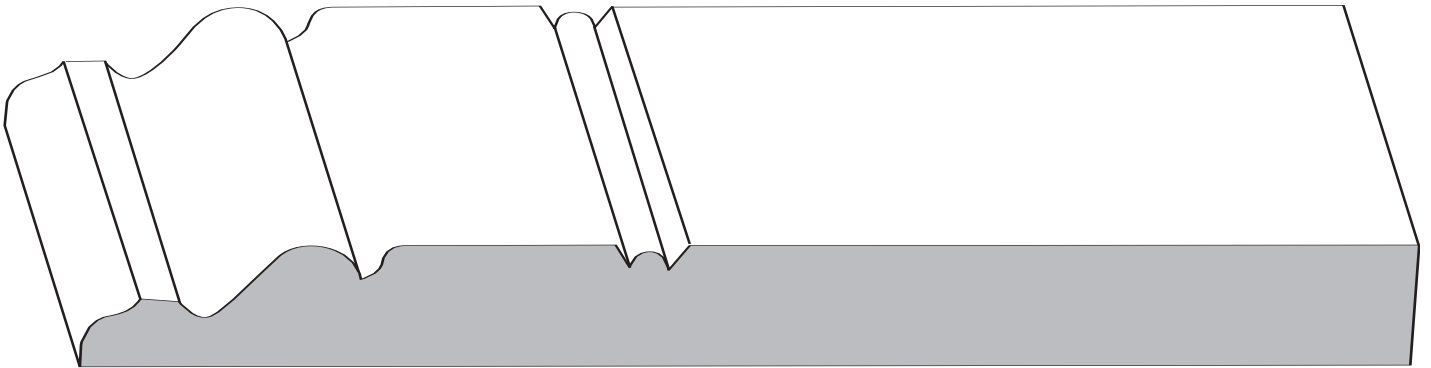

WM212-T
 $1\frac{1}{16} \times 7$

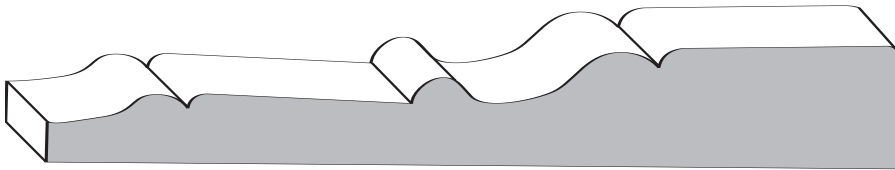

WM811
 $1\frac{1}{16} \times 4\frac{1}{2}$

CASING

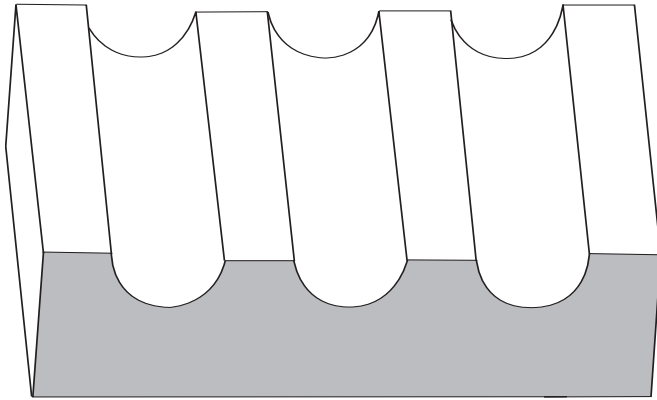

AL004-Fluted only
 $\frac{15}{16} \times 3\frac{1}{4}$

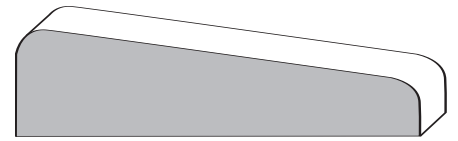

DWHWC
 DW218
 $\frac{5}{8} \times 2\frac{1}{8}$

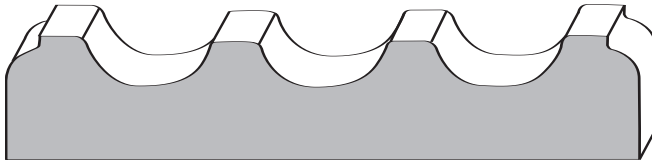

DWC10
 $\frac{11}{16} \times 3\frac{3}{8}$

Same Profile:
 EL101
 PM102
 $\frac{5}{8} \times 2\frac{1}{4}$

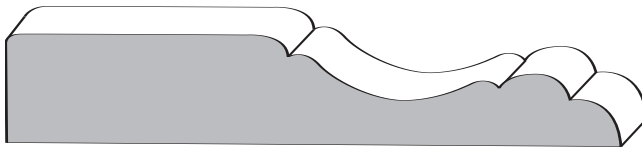

CO774-H
 $\frac{9}{16} \times 3\frac{1}{4}$

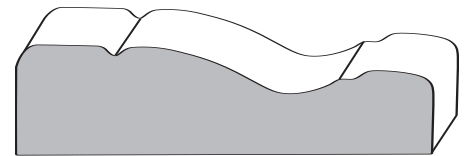

DW212
 $\frac{5}{8} \times 2\frac{3}{8}$

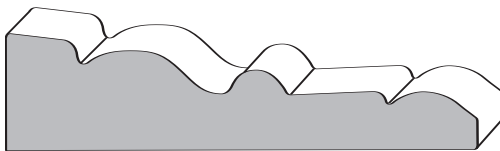

DC211
 $\frac{5}{8} \times 2\frac{1}{2}$

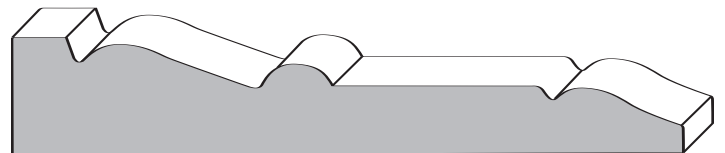

DLC 11
 $\frac{5}{8} \times 3\frac{1}{2}$

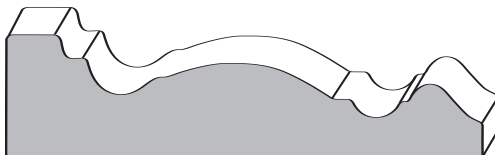

DC322
 $\frac{5}{8} \times 2\frac{1}{2}$

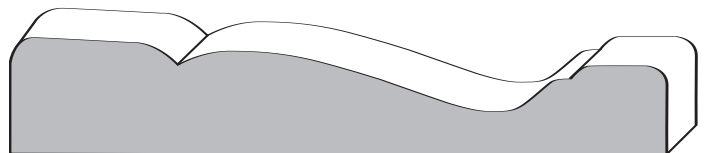

DW "A" COLONIAL $3\frac{1}{2}$ "
 TX-A3
 $\frac{5}{8} \times 3\frac{1}{2}$

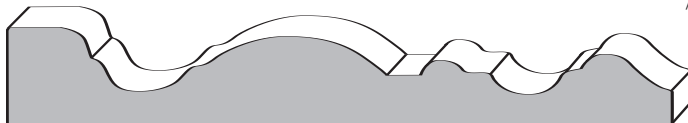

DC522
 $\frac{9}{16} \times 3\frac{1}{2}$



CASING

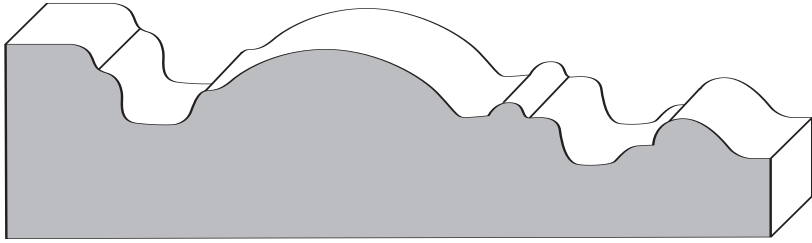

DWC22
1 x 4

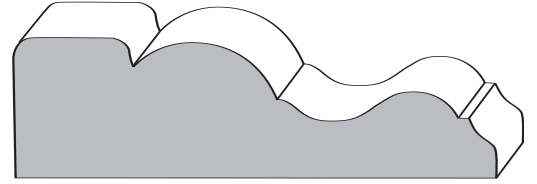

EL128-U
 $\frac{11}{16} \times 2\frac{1}{2}$

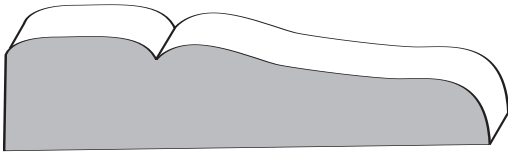

EL108-U
 $\frac{5}{8} \times 2\frac{1}{2}$

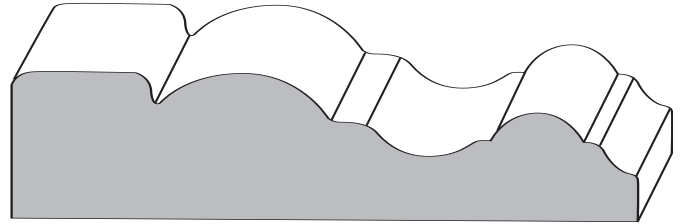

EL129-U
 $\frac{11}{16} \times 3\frac{1}{4}$

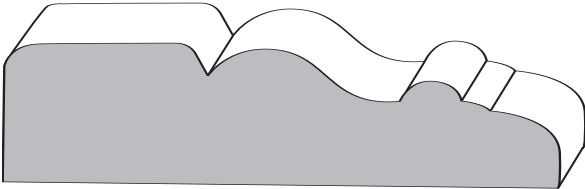

EL125-U
 $\frac{11}{16} \times 2\frac{7}{8}$

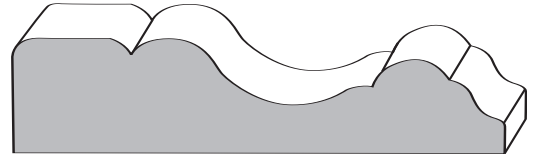

EL150-U
 $\frac{5}{8} \times 2\frac{1}{2}$

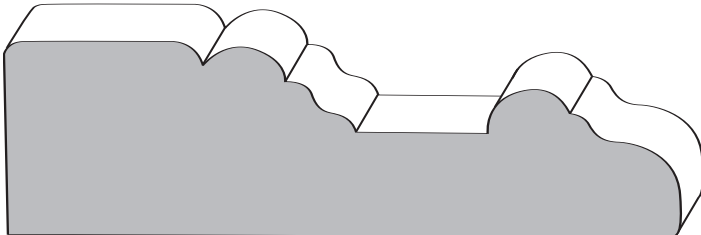

EL126-U
1 x $3\frac{1}{2}$

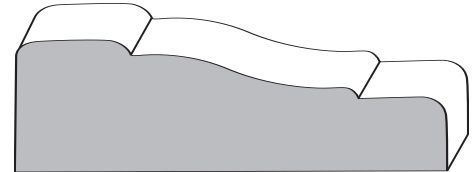

EL152-U
 $\frac{5}{8} \times 2\frac{1}{4}$

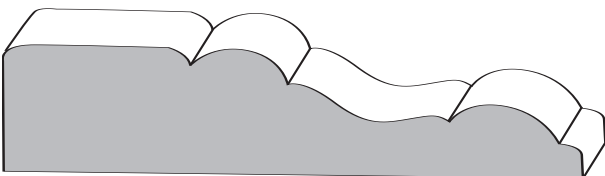

EL127-U
 $\frac{5}{8} \times 3$

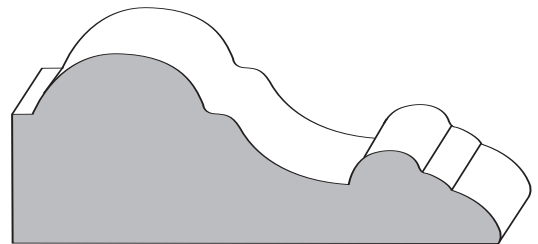

EL159-U
1 x $2\frac{1}{2}$



CASING

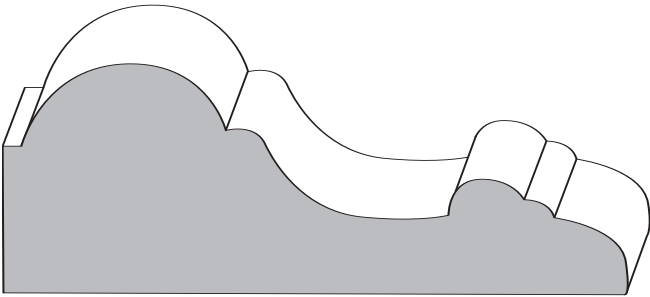

EL160-U
 $1\frac{3}{16} \times 3\frac{3}{16}$

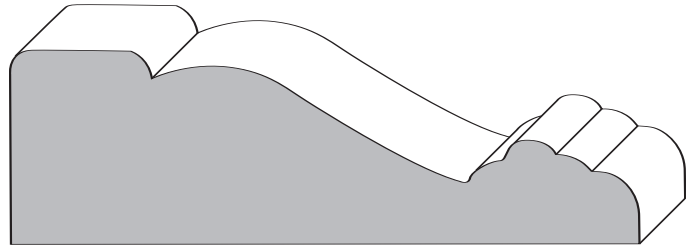

EL170-U
 $1 \times 3\frac{1}{4}$

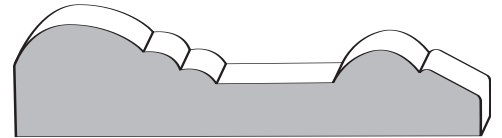

HO-04
 $\frac{5}{8} \times 2\frac{1}{2}$

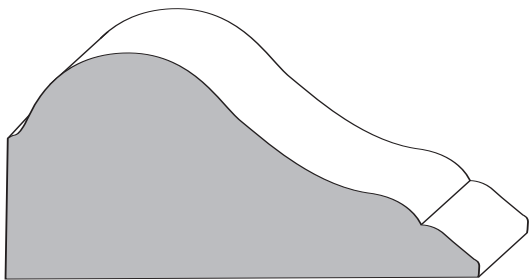

EL164-U
 $1\frac{1}{4} \times 2\frac{1}{2}$

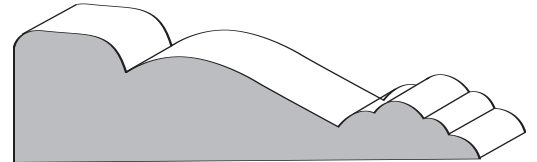

HO400
 $\frac{11}{16} \times 2\frac{1}{2}$

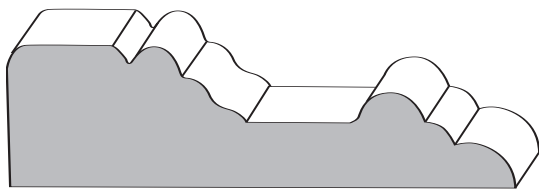

EL168-U
 $\frac{3}{4} \times 2\frac{5}{8}$

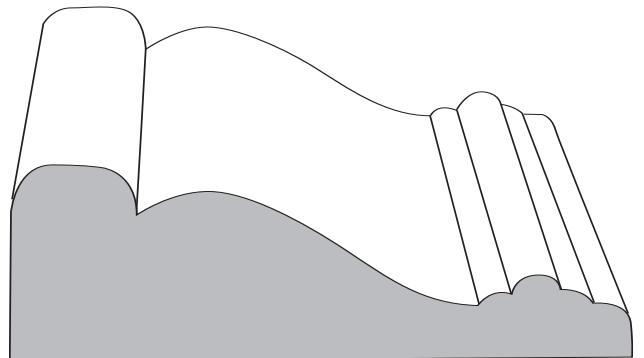

HO401
 $1 \times 3\frac{1}{4}$

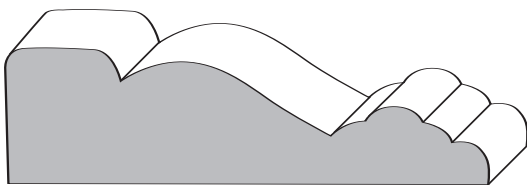

EL169-U
 $\frac{11}{16} \times 2\frac{1}{2}$

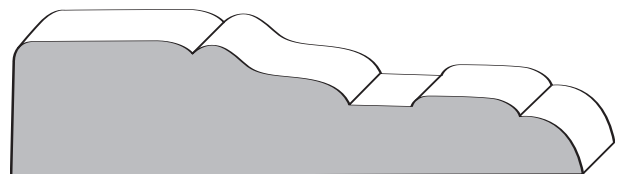

HO404
 $\frac{11}{16} \times 3$



CASING

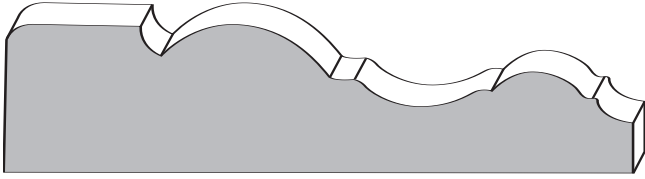

HO406
 $\frac{3}{4} \times 3\frac{1}{4}$

S1135-M
 $\frac{3}{4} \times 3\frac{1}{4}$

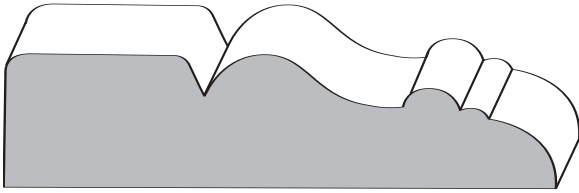

HO440-M
 $\frac{11}{16} \times 2\frac{7}{8}$

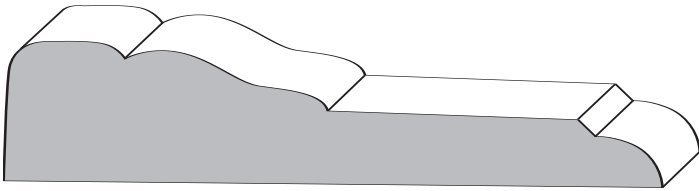

HO631
 $\frac{11}{16} \times 3\frac{1}{2}$

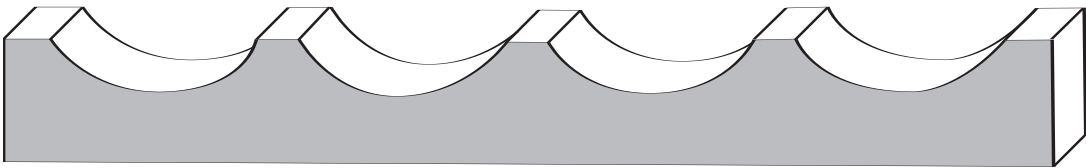

HO635
 $\frac{11}{16} \times 5\frac{1}{2}$

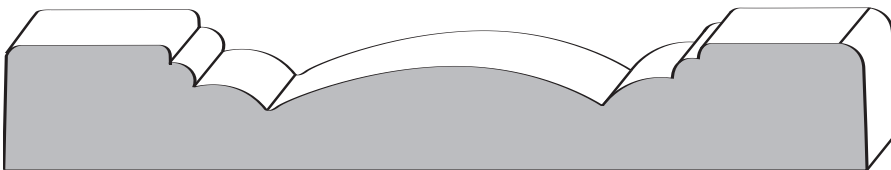

HO636
 $\frac{11}{16} \times 4\frac{1}{2}$

CASING

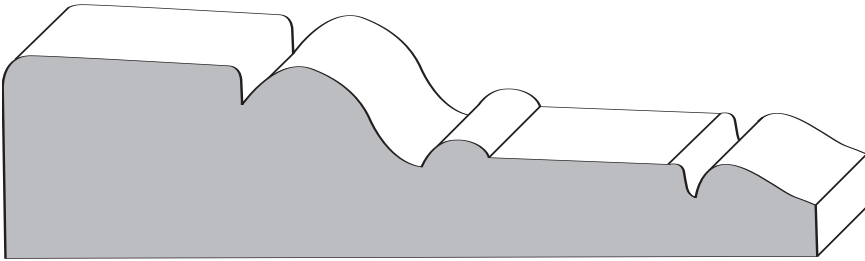

HO644-N
1 x 4³/₈

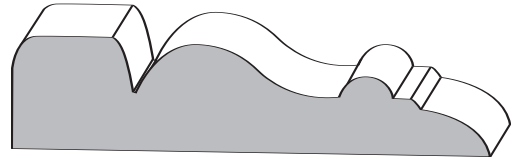

KE-32-M
5/8 x 2¹/₂

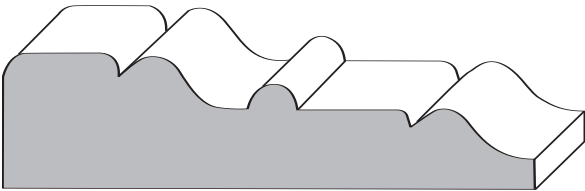

KE002 CUSTOM
3/4 x 2³/₄

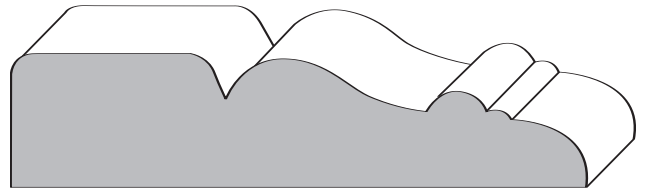

KE028-M
5/8 x 3

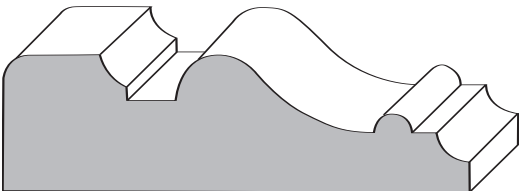

KE008-M
11/16 x 2⁷/₁₆

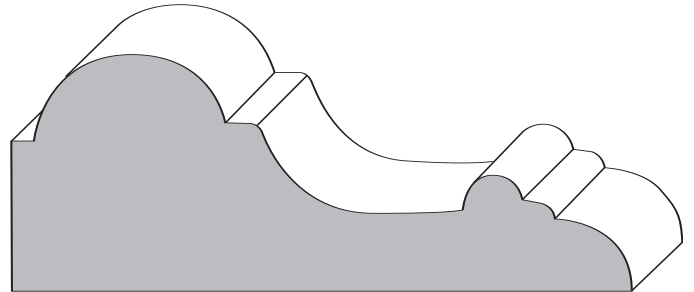

KE-36-M
1³/₁₆ x 3¹/₄

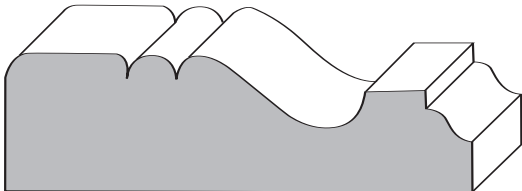

KE013
11/16 x 2⁷/₁₆

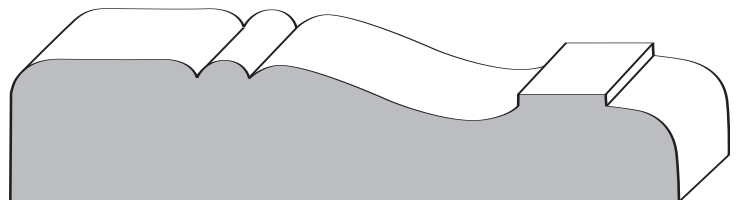

KE-40-M
11/16 x 3¹/₄

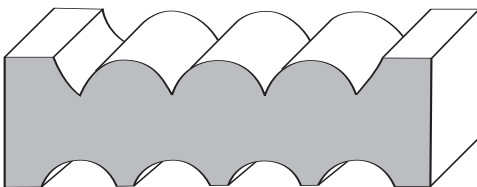

KE027
11/16 x 2¹/₄
specify bead or flute side

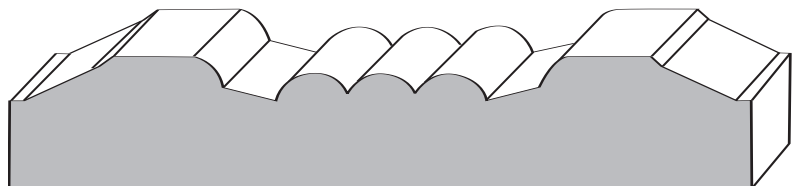

KE-42-M
3/4 x 4



CASING

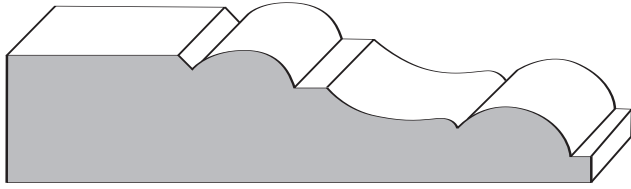

KE-72-M
 $\frac{5}{8} \times 3$

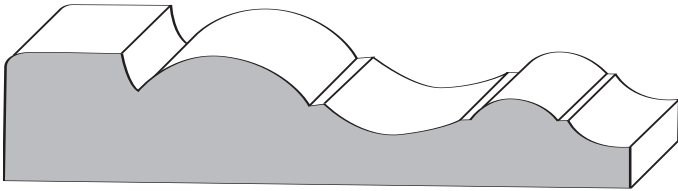

KE116
 $\frac{5}{8} \times 3\frac{1}{4}$

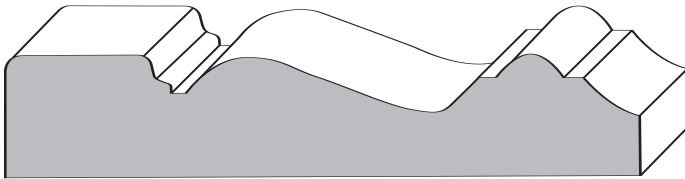

KE124-M
 $\frac{11}{16} \times 3\frac{1}{4}$

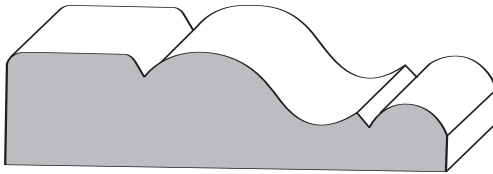

KE142-M
 $\frac{5}{8} \times 2\frac{1}{4}$

CASING

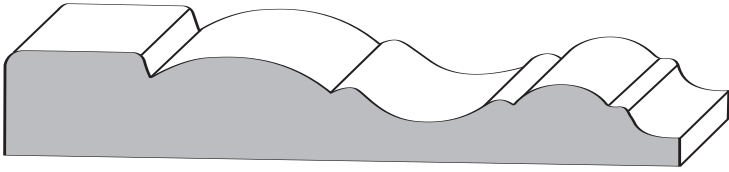

KE145-M
 $\frac{5}{8} \times 3\frac{1}{2}$

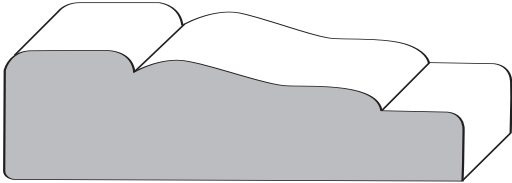

KE240
 $\frac{5}{8} \times 2\frac{1}{4}$

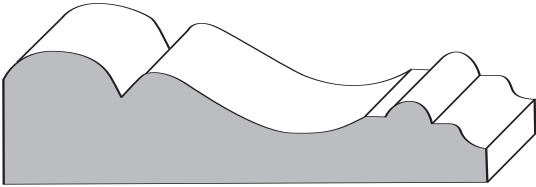

KE201
 $\frac{11}{16} \times 2\frac{1}{2}$

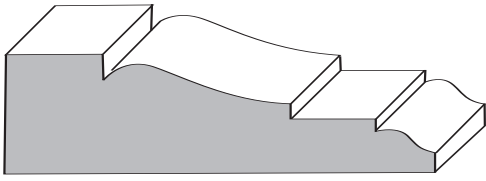

KE241
 $\frac{5}{8} \times 2\frac{1}{4}$

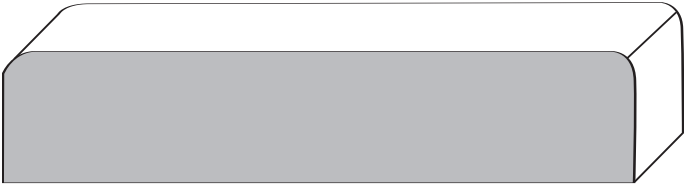

KE236-M
PM114
 $\frac{9}{16} \times 3\frac{1}{4}$

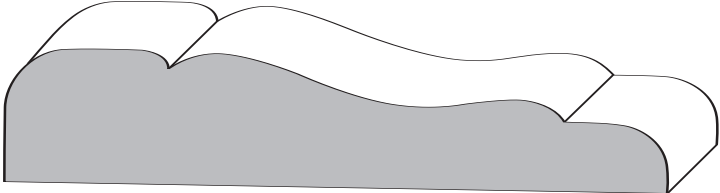

KE242-M
 $\frac{5}{8} \times 3\frac{1}{8}$

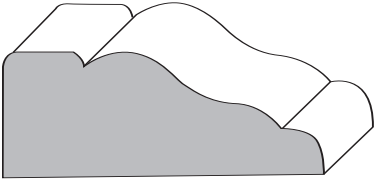

KE238
 $\frac{5}{8} \times 1\frac{5}{8}$

KE238-M
 $\frac{5}{8} \times 1\frac{5}{8}$

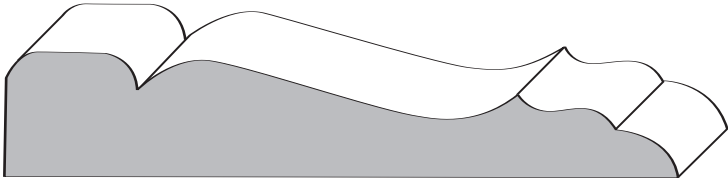

KE243
 $\frac{11}{16} \times 3\frac{1}{2}$

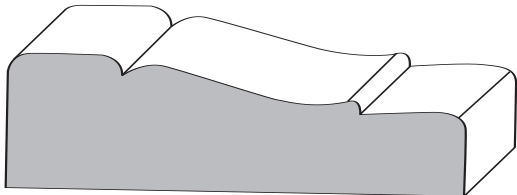

KE239-M
 $\frac{5}{8} \times 2\frac{1}{4}$

JELCH-M
 $\frac{5}{8} \times 2\frac{1}{4}$

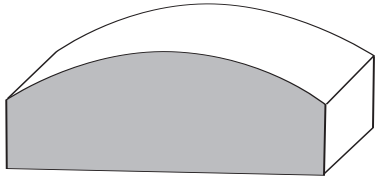

KE244
 $\frac{9}{16} \times 1\frac{5}{8}$



CASING

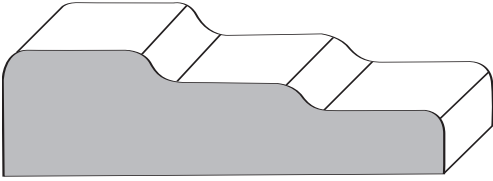

KE250
 $\frac{5}{8} \times 2\frac{1}{4}$

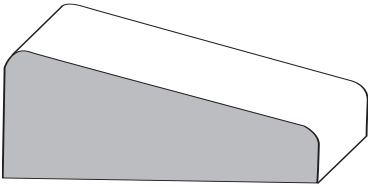

KE256-M
 $\frac{9}{16} \times 1\frac{9}{16}$

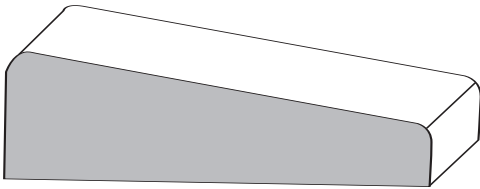

KE258-M
 $\frac{9}{16} \times 2\frac{1}{4}$

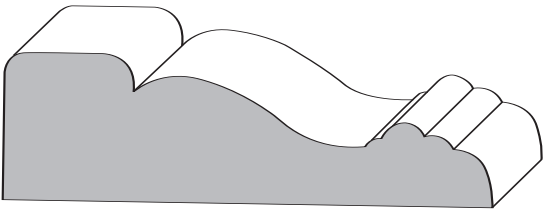

KE262-M
 $\frac{11}{16} \times 2\frac{1}{2}$

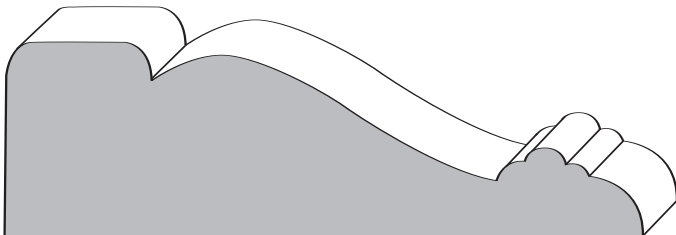

KE380-M
 $1 \times 3\frac{1}{4}$

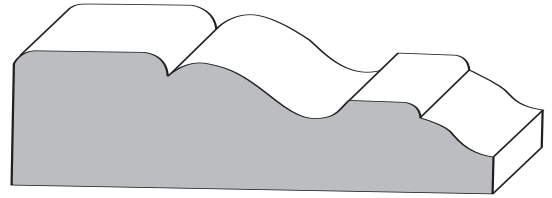

KE385-M
 $\frac{5}{8} \times 2\frac{1}{2}$

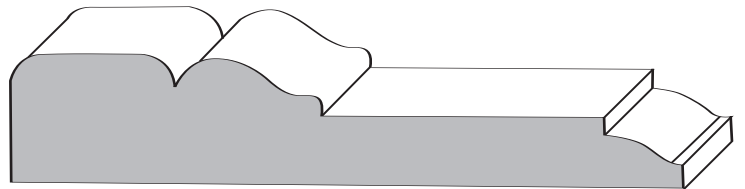

KE391
 $\frac{11}{16} \times 3\frac{1}{2}$

PM187
 $\frac{11}{16} \times 3\frac{1}{2}$

KE391-M (not pictured)
 $\frac{11}{16} \times 3\frac{1}{2}$

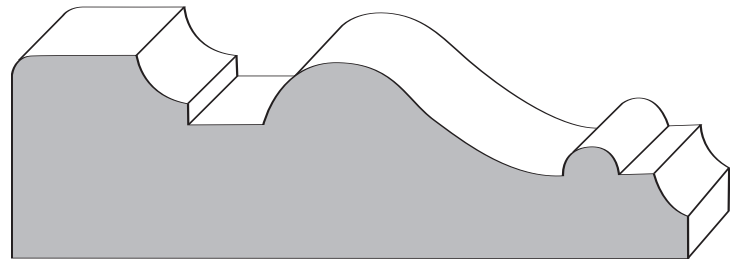

KE393-M
 $1\frac{1}{16} \times 3\frac{7}{16}$

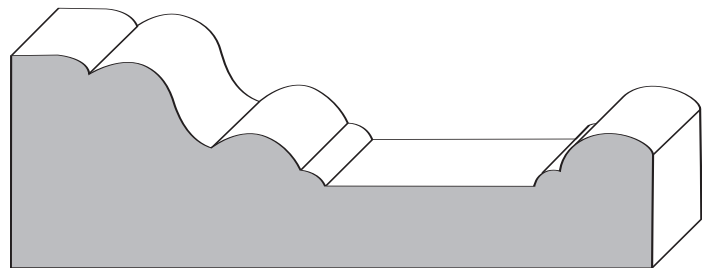

KE387
 $1\frac{1}{16} \times 3\frac{3}{4}$

KE387-M (not pictured)
 $1\frac{1}{16} \times 3\frac{3}{4}$

CASING

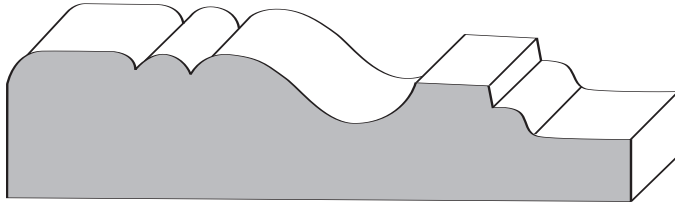

KE388
 $\frac{11}{16} \times 3\frac{1}{4}$

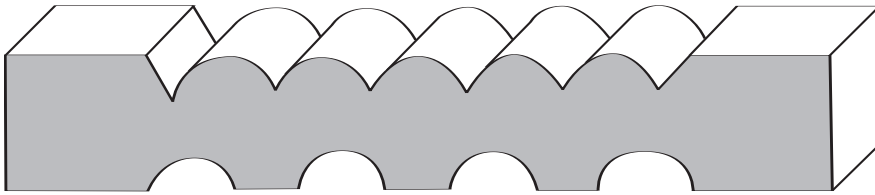

KE389-M Specify 5-bead or 4-flute side
 $\frac{11}{16} \times 4\frac{1}{4}$

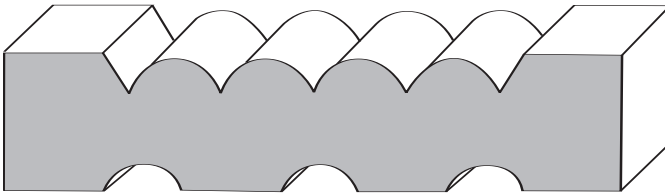

KE386 Specify 4-bead or 3-flute side
 $\frac{11}{16} \times 3\frac{1}{4}$

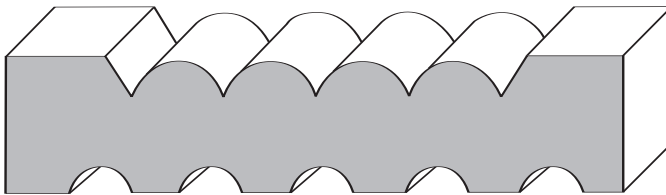

KE386-M Specify 4-bead or 5-flute
 $\frac{5}{8} \times 3\frac{1}{4}$

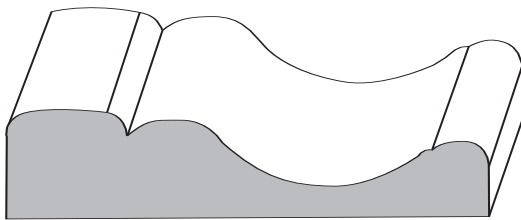

LC212
 $\frac{11}{16} \times 2\frac{1}{2}$



CASING

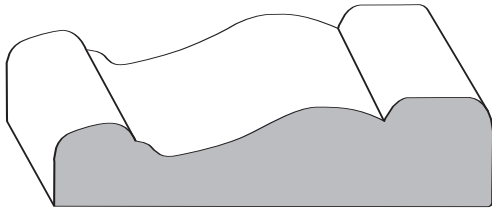

LC214
 $\frac{5}{8} \times 2\frac{1}{4}$

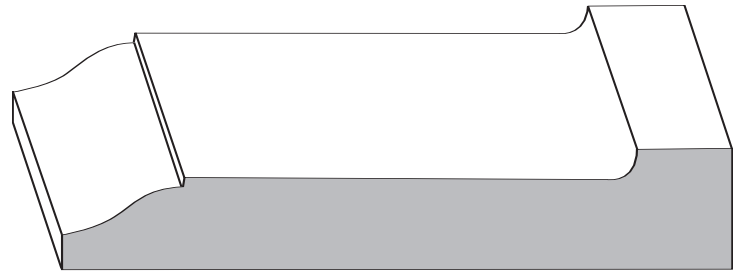

LC347
 $\frac{5}{8} \times 3\frac{1}{2}$

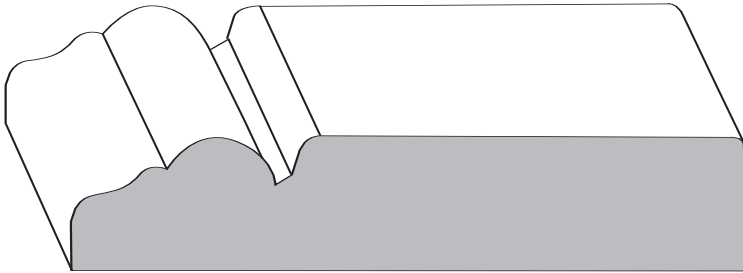

LC295
 $1\frac{1}{16} \times 3\frac{1}{2}$

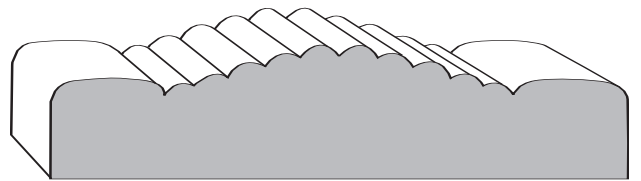

LH-C9
 $1\frac{1}{16} \times 3$

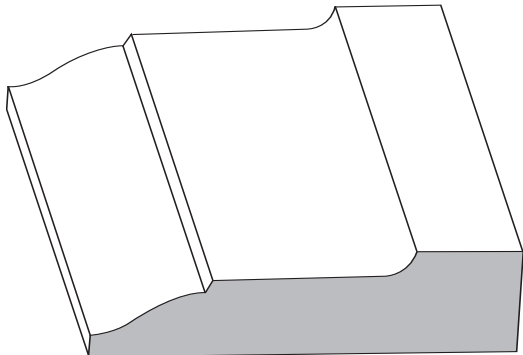

LC346
 $\frac{9}{16} \times 2\frac{1}{4}$

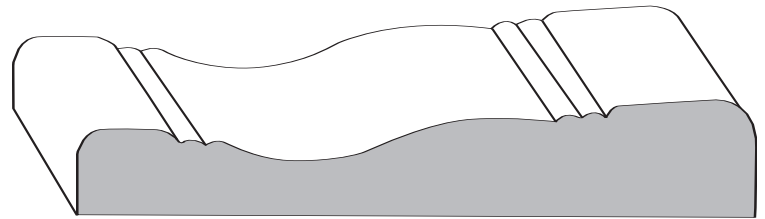

LHC15
 $\frac{5}{8} \times 3\frac{1}{2}$

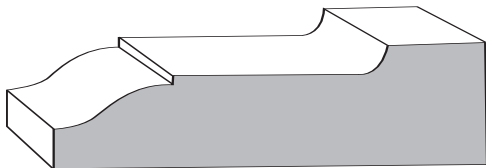

LC346
 $\frac{5}{8} \times 2\frac{1}{4}$

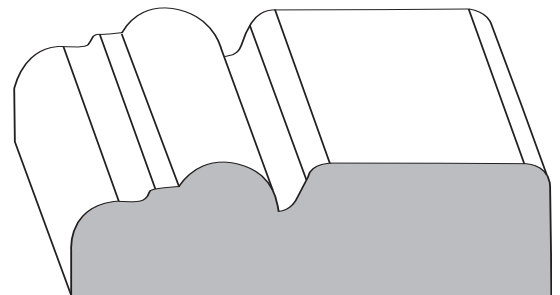

LS195
 $1\frac{1}{16} \times 2\frac{1}{2}$

CASING

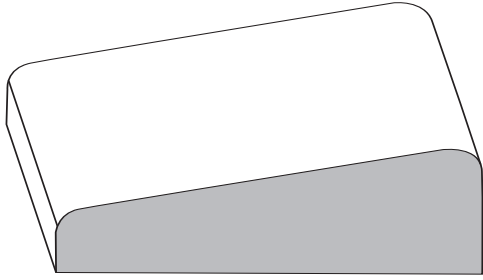

LSC-2
 $1\frac{1}{16} \times 2\frac{1}{4}$

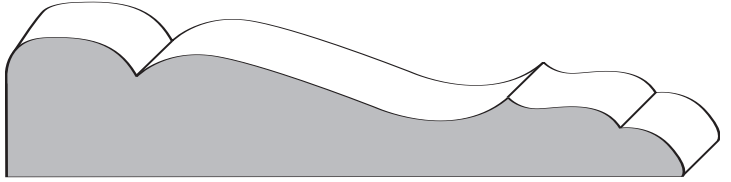

OR361
 $1\frac{1}{16} \times 3\frac{1}{2}$

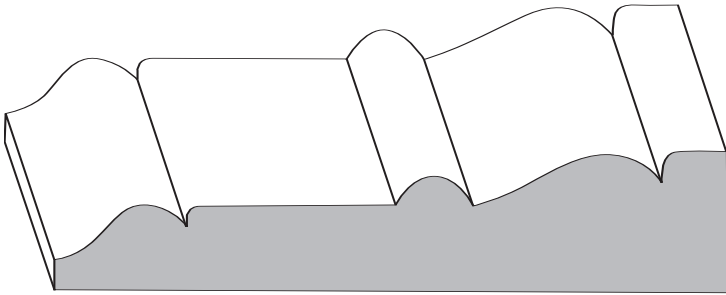

LSC12
 $1\frac{1}{16} \times 3\frac{1}{2}$

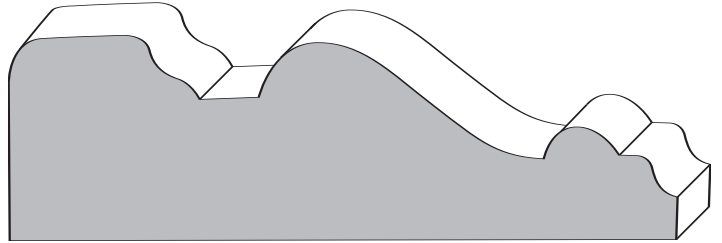

OR393-S
 $1\frac{1}{16} \times 3\frac{1}{2}$

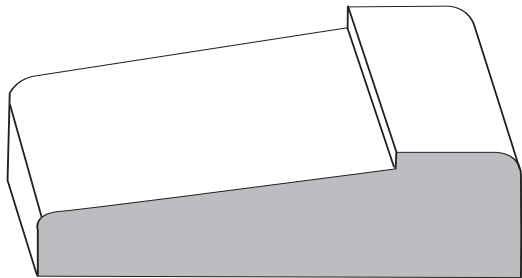

LSC20
 $1\frac{1}{16} \times 2\frac{1}{2}$

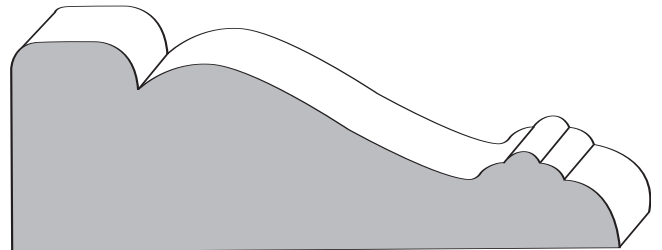

OR490-M
 $1 \times 3\frac{1}{4}$

KE-34
 $1 \times 3\frac{1}{4}$

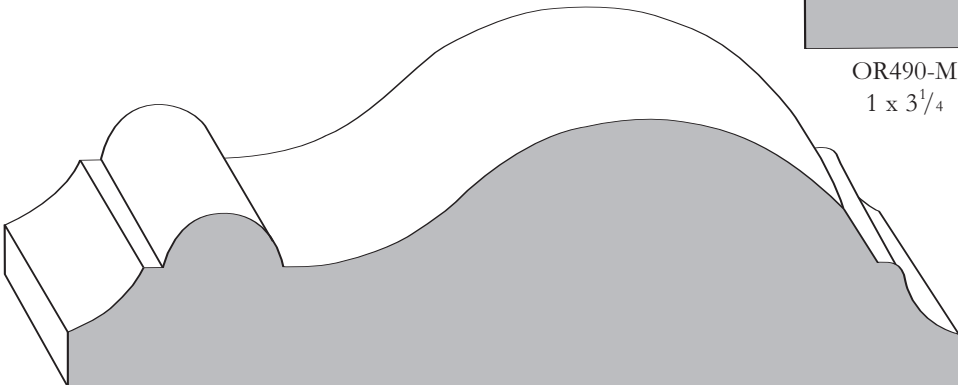

LSMM1
 $1\frac{1}{2} \times 4\frac{5}{8}$



CASING

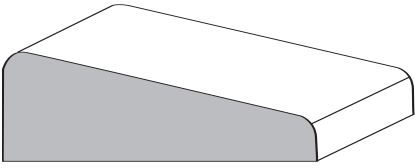

S1101
 $\frac{5}{8} \times 1 \frac{5}{8}$

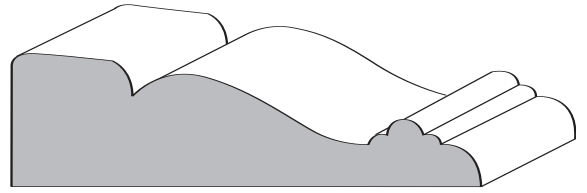

S1109
 $\frac{11}{16} \times 2 \frac{7}{16}$

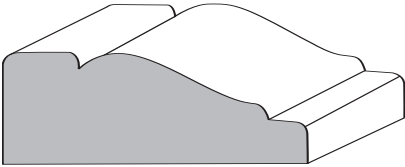

S1103
 $\frac{5}{8} \times 1 \frac{5}{8}$

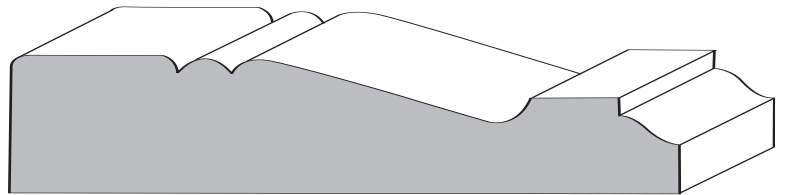

S1110
 $\frac{11}{16} \times 3 \frac{7}{16}$

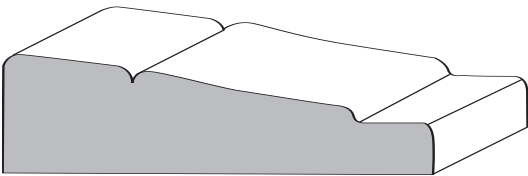

S1104
 $\frac{5}{8} \times 2 \frac{1}{4}$

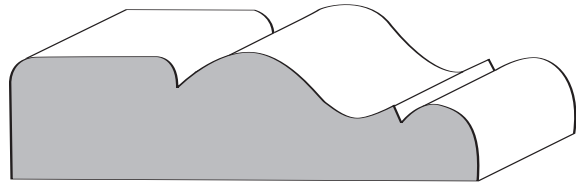

S1111
 $\frac{11}{16} \times 2 \frac{7}{16}$

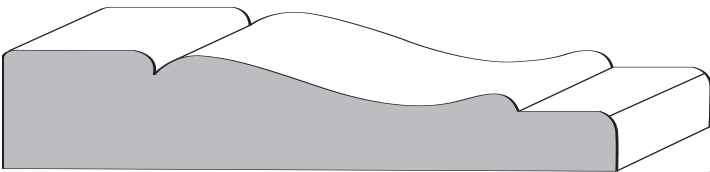

S1105
 $\frac{5}{8} \times 3 \frac{1}{4}$

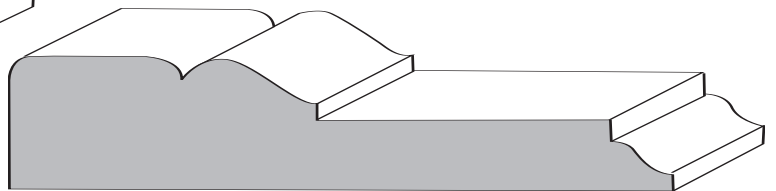

S1112
 $\frac{11}{16} \times 3 \frac{7}{16}$

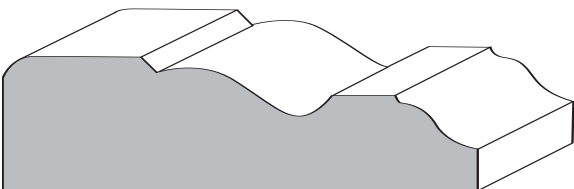

S1106
 $\frac{11}{16} \times 2 \frac{7}{16}$

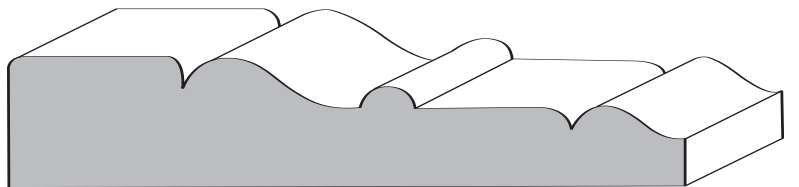

S1121
 $\frac{11}{16} \times 3 \frac{1}{2}$

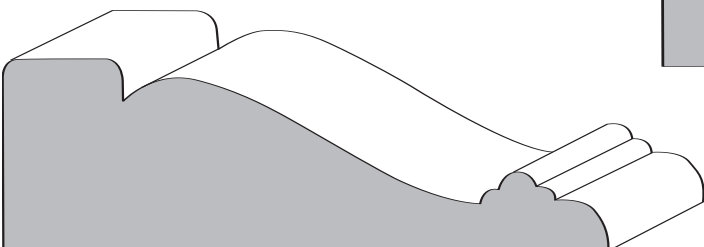

S1107
 $1 \times 3 \frac{3}{16}$



CASING

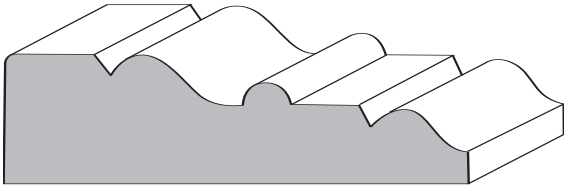

S1122
 $1\frac{11}{16} \times 2\frac{7}{16}$

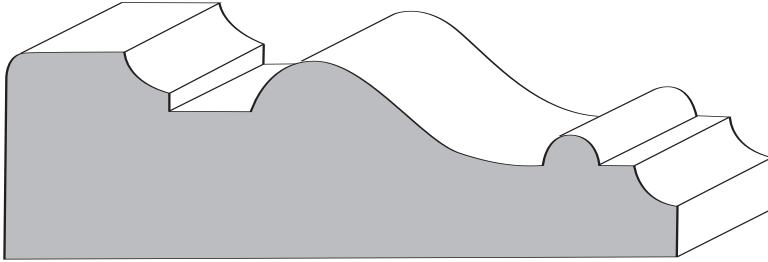

S1124
 $1\frac{1}{16} \times 3\frac{1}{2}$

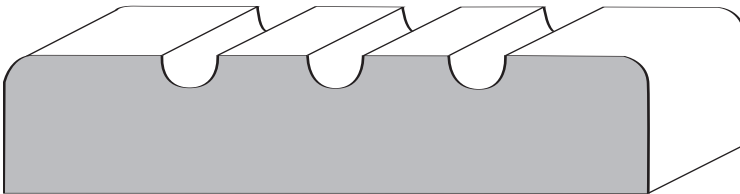

S1126
 $1\frac{11}{16} \times 3\frac{7}{16}$

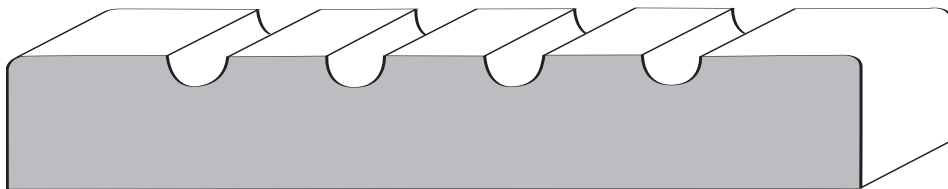

S1127
 $1\frac{11}{16} \times 4\frac{7}{16}$

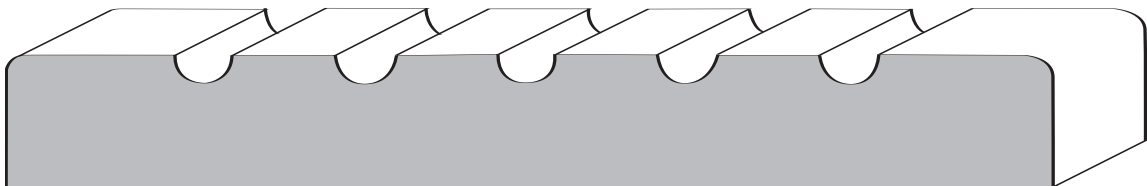

S1128
 $1\frac{11}{16} \times 5\frac{7}{16}$

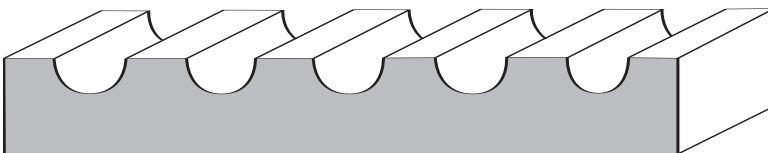

S1139
 $\frac{1}{2} \times 3\frac{1}{2}$



CASING

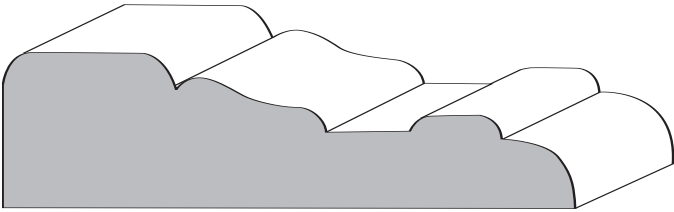

S1130
 $1\frac{3}{16} \times 3$

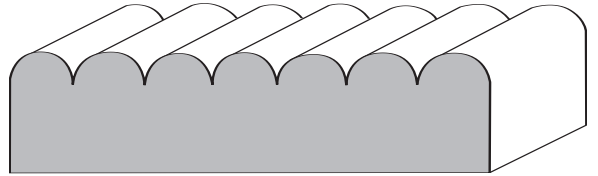

S1136
 $\frac{5}{8} \times 2\frac{1}{2}$

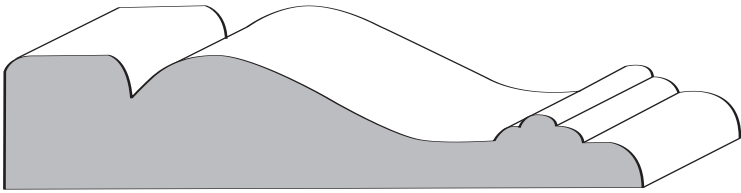

S1131
 $1\frac{1}{16} \times 3\frac{1}{4}$

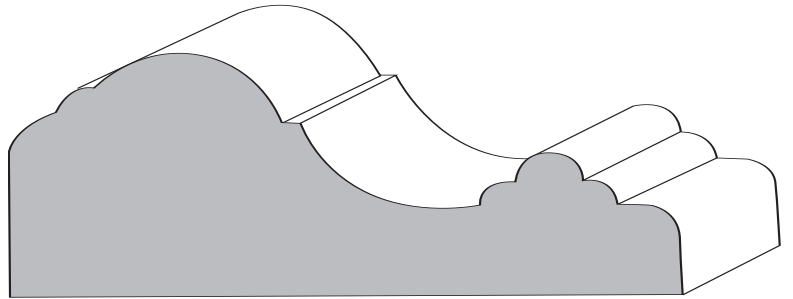

S1152
 $1\frac{1}{4} \times 3\frac{1}{2}$

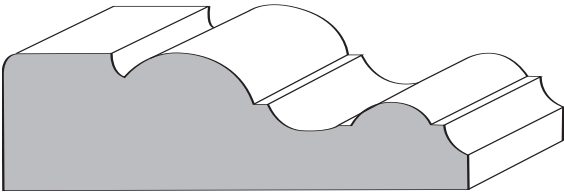

S1134
 $1\frac{1}{16} \times 2\frac{7}{16}$

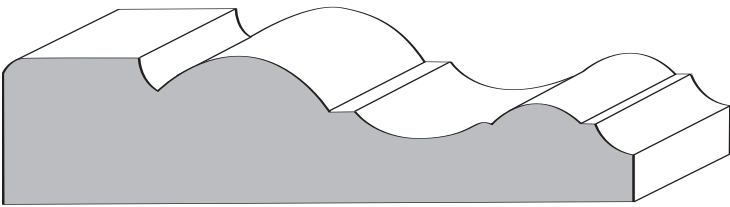

S1135
 $\frac{3}{4} \times 3\frac{1}{4}$

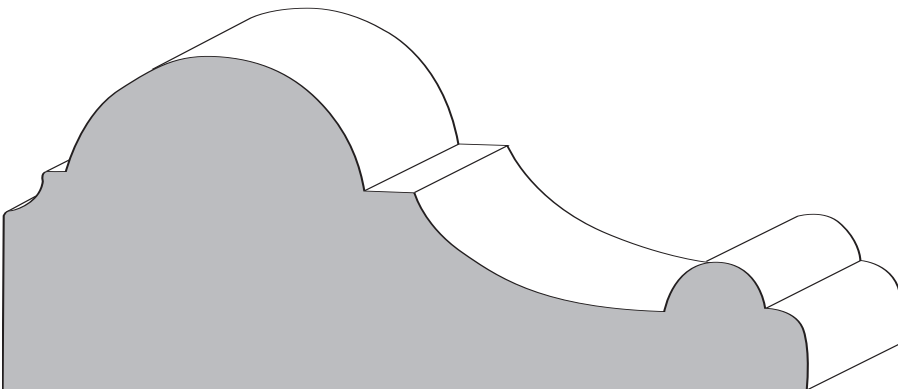

S1151
 $1\frac{3}{4} \times 4\frac{1}{4}$

CASING

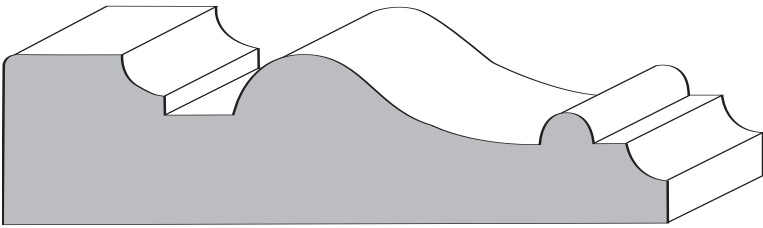

S1156
 $\frac{7}{8} \times 3\frac{1}{2}$

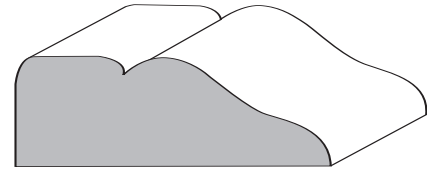

S1160
 $\frac{5}{8} \times 1\frac{5}{8}$

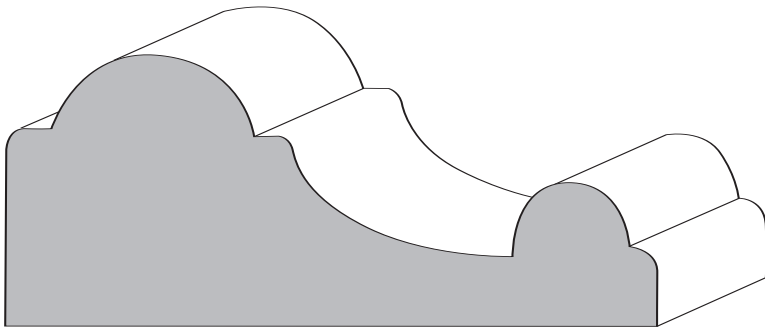

S1157
 $1\frac{3}{8} \times 3\frac{3}{8}$

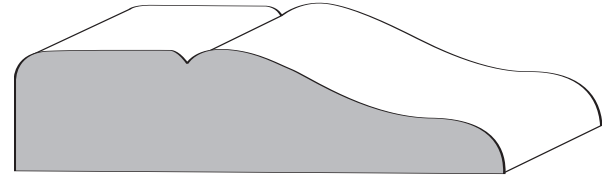

S1161
 $\frac{5}{8} \times 2\frac{1}{2}$

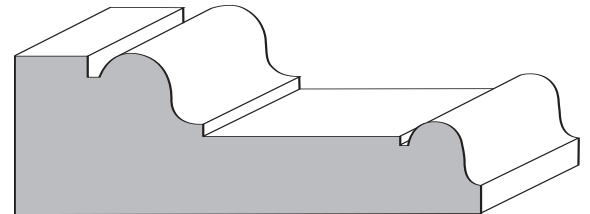

S1186
 $\frac{5}{16} \times 2\frac{7}{16}$

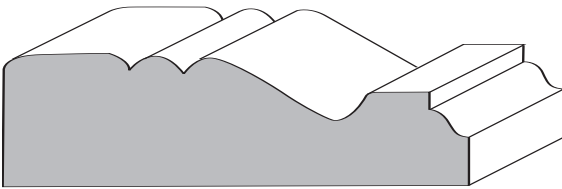

S1158
 $1\frac{1}{16} \times 2\frac{7}{16}$

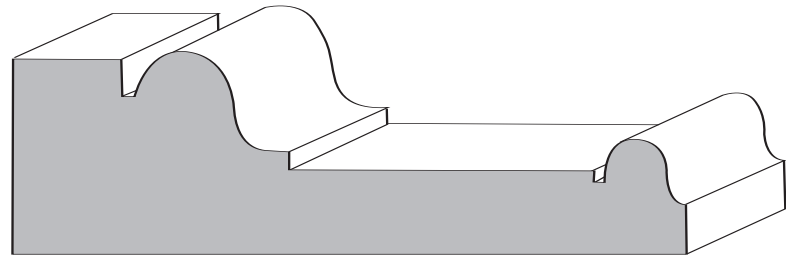

S1187
 $1 \times 3\frac{1}{2}$

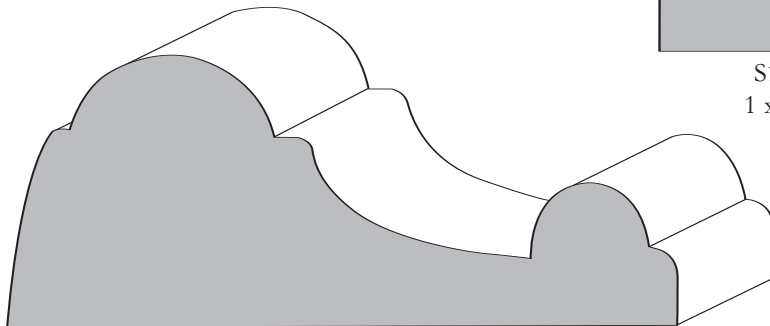

S1159
 $1\frac{3}{8} \times 3\frac{1}{2}$

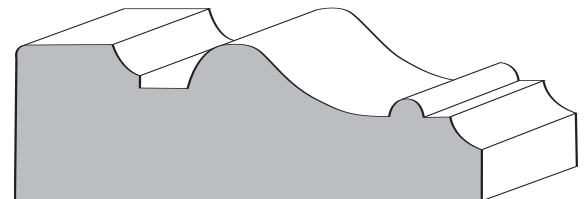

S1154
 $1\frac{3}{16} \times 2\frac{7}{16}$



CASING

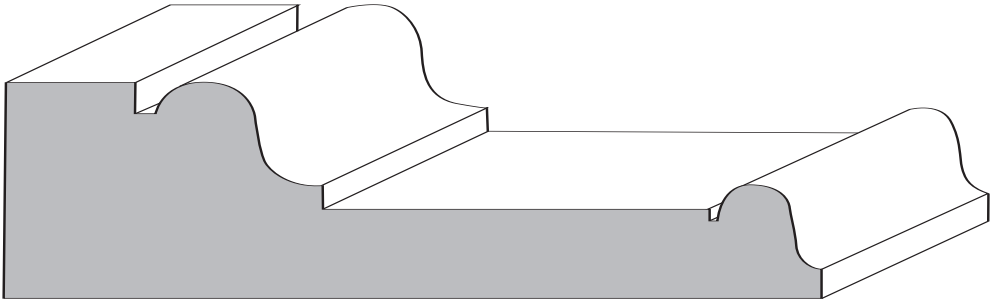

S1188
 $1 \frac{1}{8} \times 4 \frac{1}{4}$

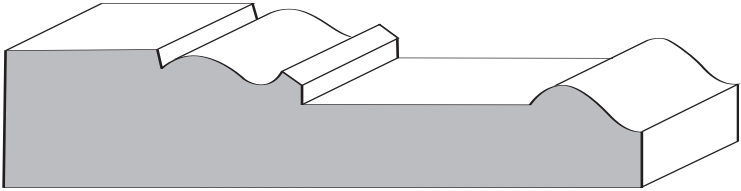

S1190
 $1 \frac{1}{16} \times 3 \frac{5}{16}$

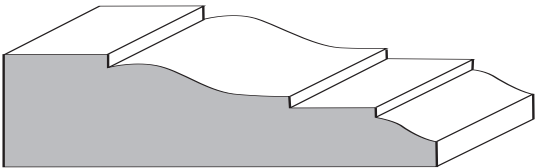

S1191
 $\frac{5}{8} \times 2 \frac{1}{4}$

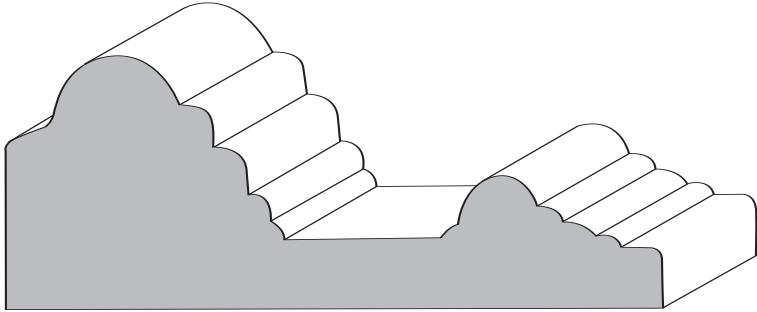

S1153
 $1 \frac{1}{4} \times 3 \frac{1}{2}$

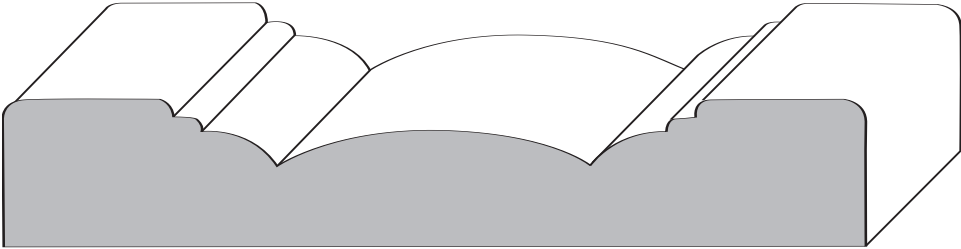

S1198
 $\frac{3}{4} \times 4 \frac{1}{2}$

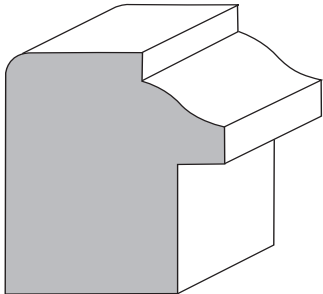

S1141
 $1 \frac{1}{8} \times 1 \frac{1}{4}$

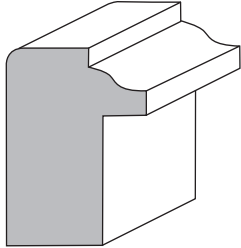

S1140
 $\frac{3}{4} \times 1$



CASING

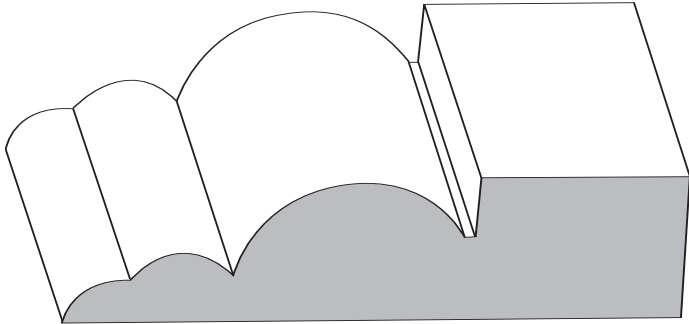

SK902
 $1\frac{3}{16} \times 3\frac{1}{4}$
Denver Case

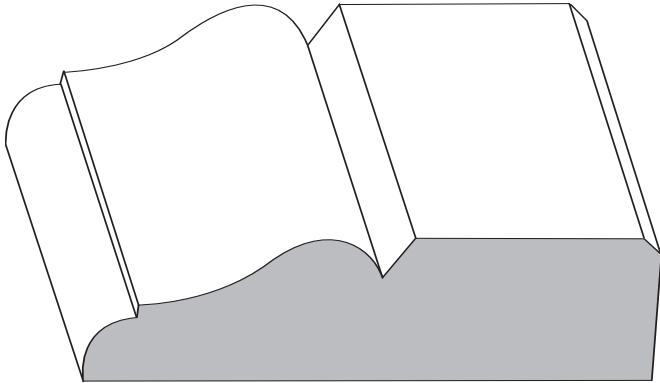

SK904
 $\frac{3}{4} \times 3$

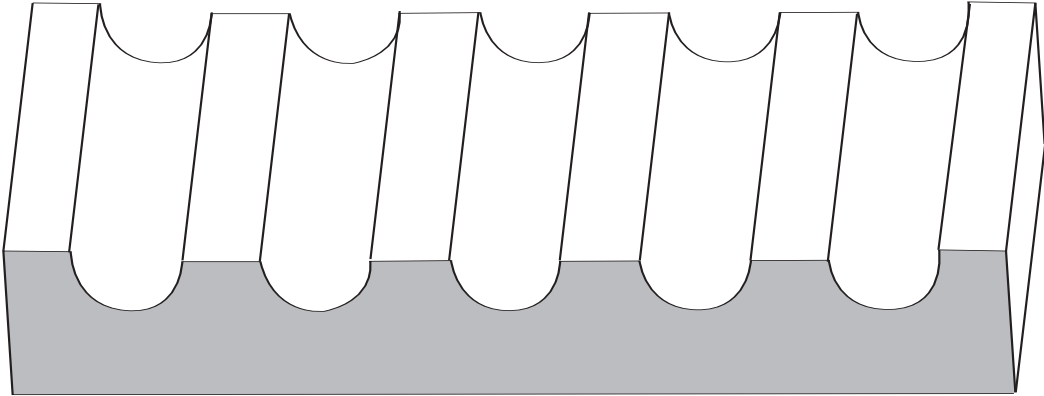

SK915 Fluted only
 $1\frac{3}{16} \times 5\frac{1}{4}$



CASING

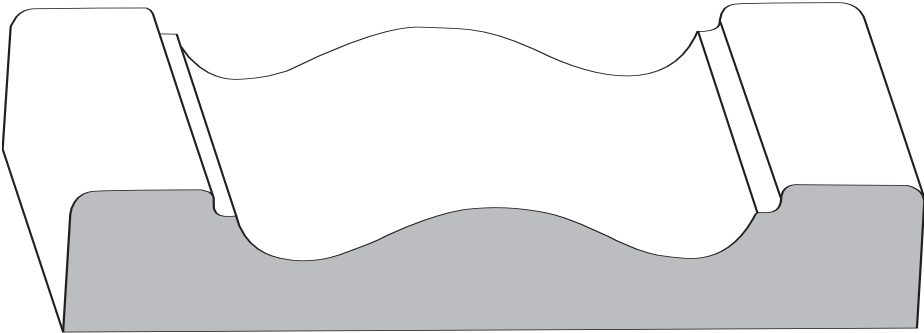

SK923
 $\frac{3}{4} \times 4\frac{1}{2}$

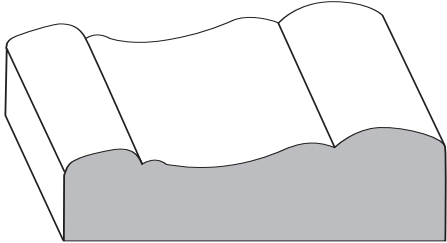

TC122
 $\frac{9}{16} \times 2$

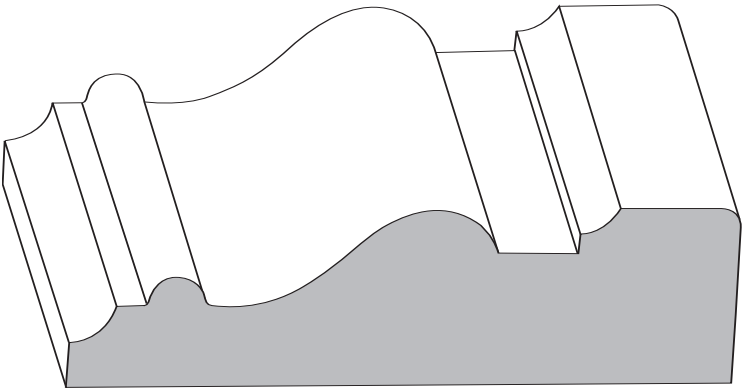

SK946
 $1 \times 3\frac{1}{2}$
 Coors Casing

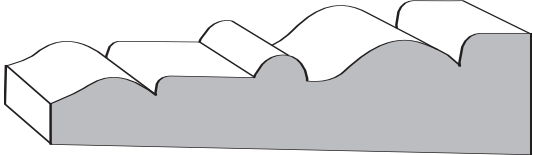

TC211
 $\frac{5}{8} \times 2\frac{1}{2}$

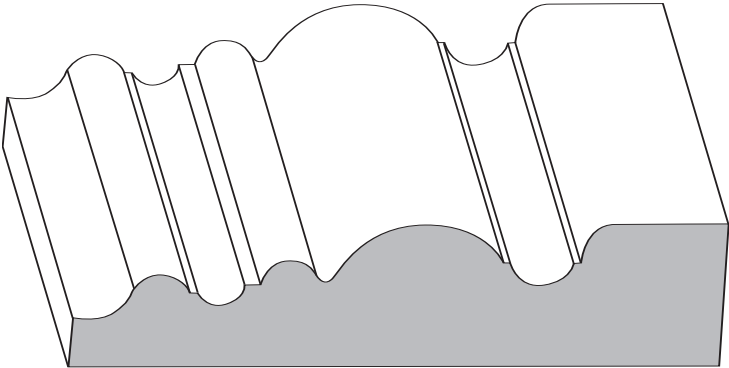

STARK-C
 $\frac{13}{16} \times 3\frac{1}{4}$

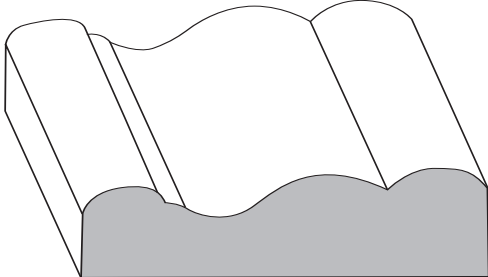

TC218
 $\frac{5}{8} \times 2\frac{1}{8}$



CASING

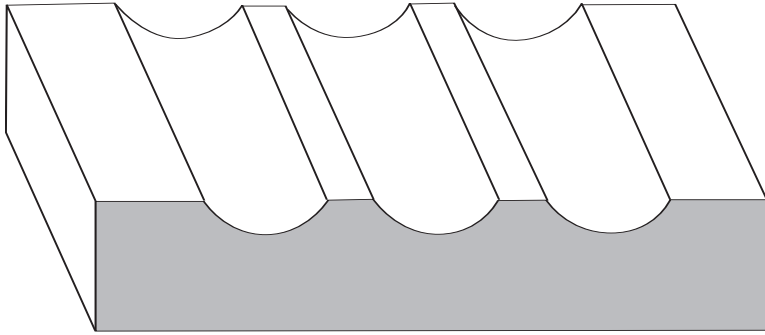

TC312
1¹¹/₁₆ x 3¹/₂

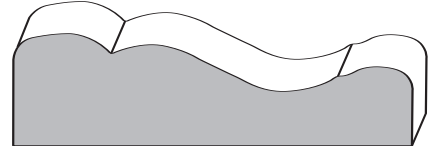

"A" Colonial 2¹/₈"
TX-AO
5⁵/₈ x 2¹/₈

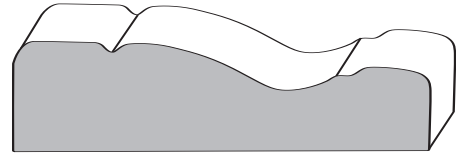

"A" Colonial 2¹/₄"
TX-A1
5⁵/₈ x 2¹/₄

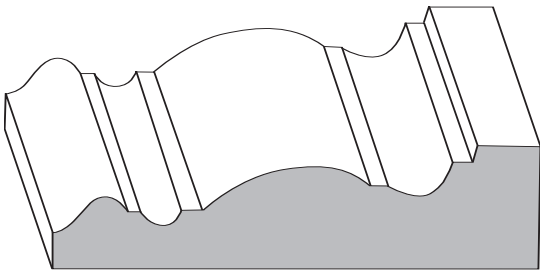

LC322
5⁵/₈ x 2¹/₂

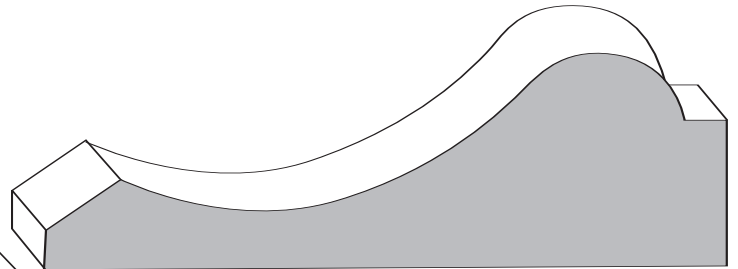

TX196
1¹/₈ x 3⁹/₁₆

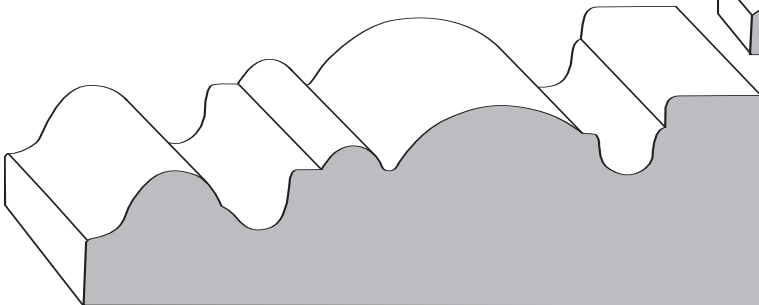

TC422
1¹/₁₆ x 3¹/₂

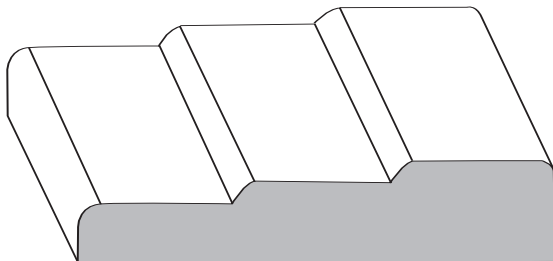

TCBS0
9⁹/₁₆ x 2¹/₂



CASING

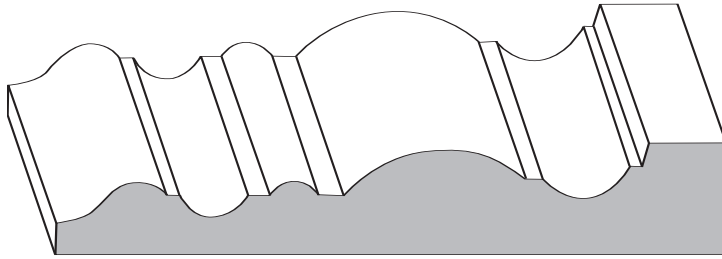

TX522
 $\frac{9}{16} \times 3\frac{1}{2}$

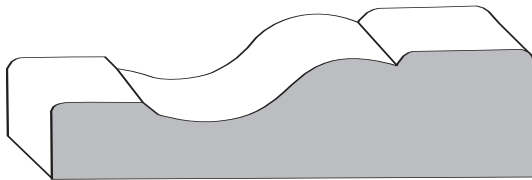

TX-C8
 $\frac{11}{16} \times 2\frac{1}{2}$

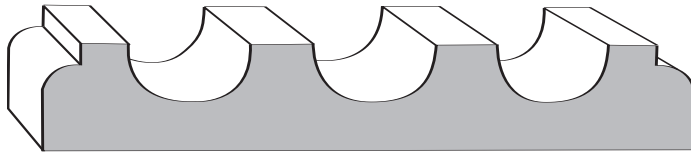

TXC10
LHC10-Oak
 $\frac{9}{16} \times 3\frac{3}{8}$

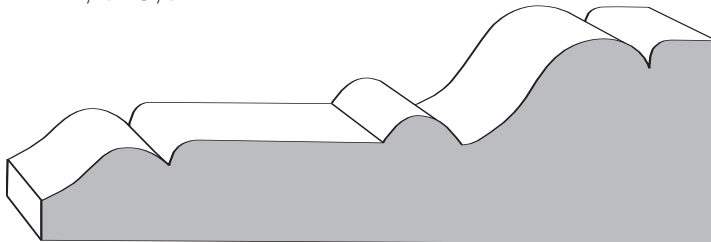

TXC11
 $1\frac{1}{16} \times 3\frac{1}{2}$

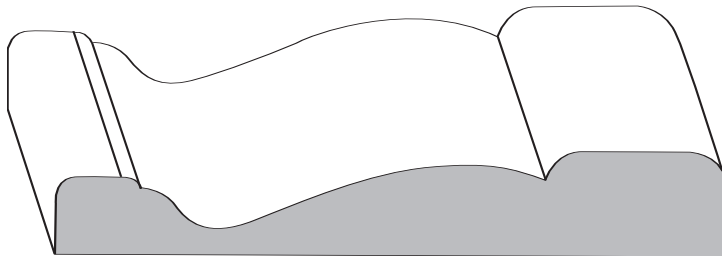

TXC13
 $\frac{5}{8} \times 3\frac{1}{2}$

CASING

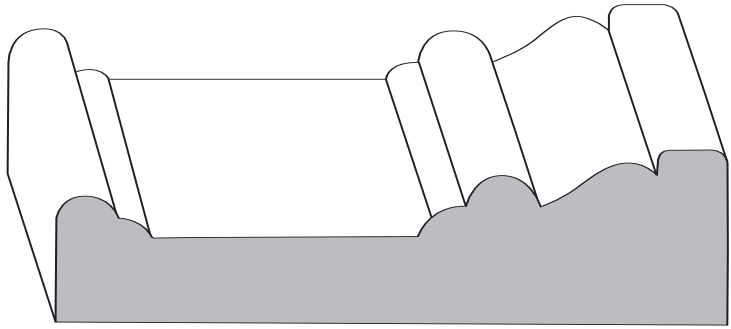

TXC14
 $\frac{7}{8} \times 3\frac{1}{2}$

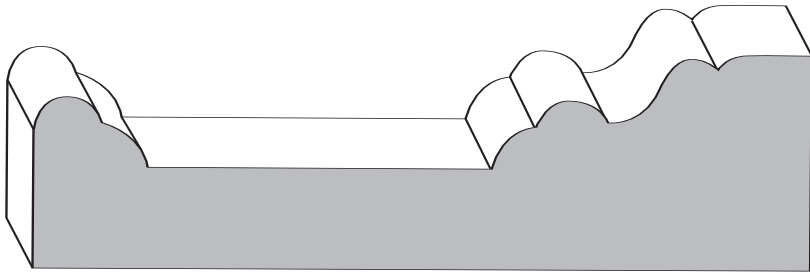

TXC26
 $1\frac{1}{16} \times 4$

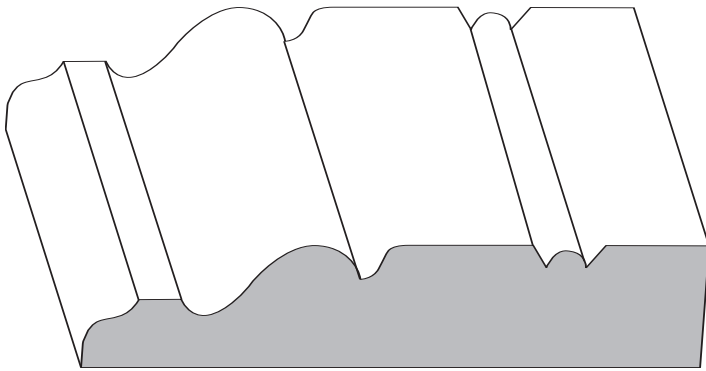

WM212-C
 $\frac{11}{16} \times 3\frac{1}{4}$



PANEL, COVE, HALF ROUND, S/4/S & MISCELLANEOUS

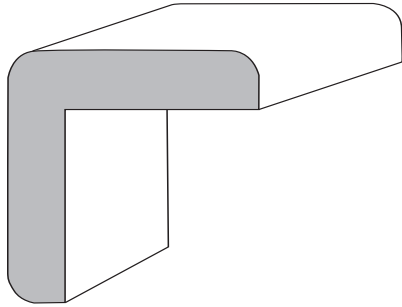

LS204
1⁵/₁₆ x 1⁵/₁₆

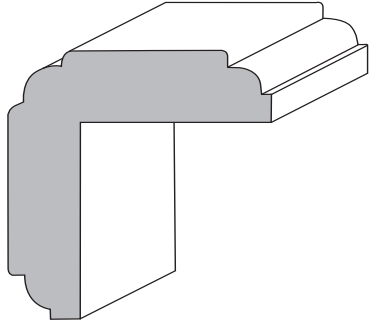

S6615
1³/₈ x 1³/₈

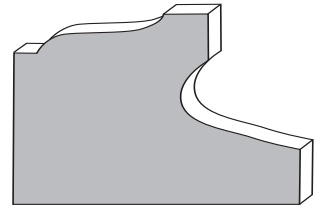

HO143
1 x 1¹/₂

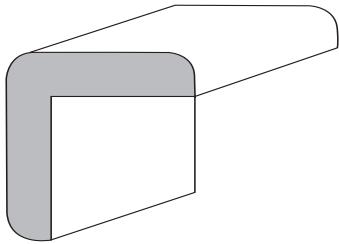

LS205
1 x 1

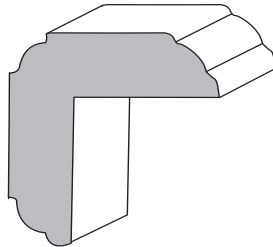

HO603 OAK
1¹/₈ x 1¹/₈

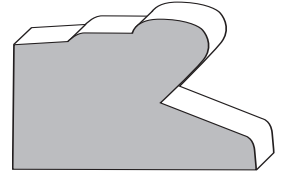

HO142
1 x 1³/₈



HO198 SCRIBE
3³/₁₆ x 3³/₄

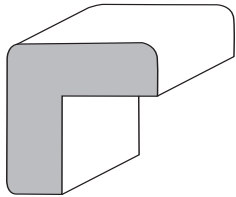

S6613
3³/₄ x 3³/₄

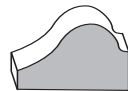

HO076
3³/₈ x 5⁵/₈



HO-36
1¹/₄ x 3³/₄

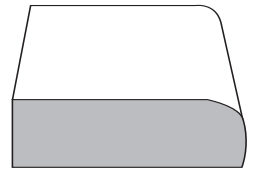

HO-42 STOP
3³/₈ x 1¹/₄

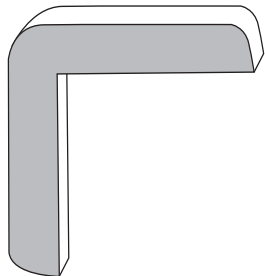

HO127
1³/₈ x 1³/₈

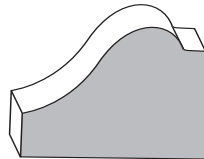

HO-78
3³/₄ x 1

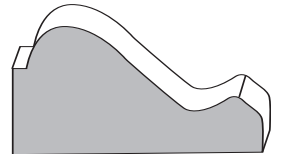

HO381
1¹¹/₁₆ x 1³/₈



HO-79
1¹/₂ x 7⁷/₈

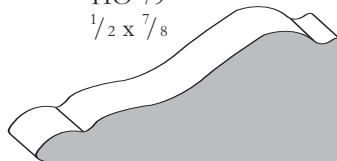

HO-80
3³/₄ x 1⁵/₈

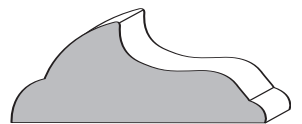

HO619
9⁹/₁₆ x 1³/₈



PANEL, COVE, HALF ROUND, S/4/S & MISCELLANEOUS

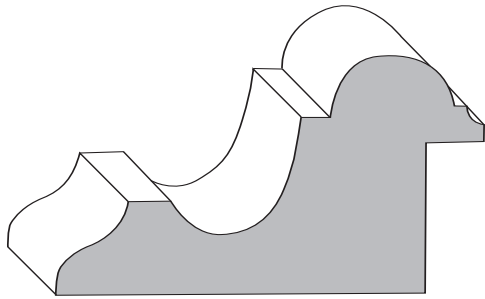

KE023
1³/₁₆ x 2³/₁₆

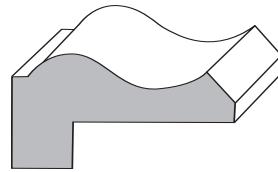

KE230
9/₁₆ x 1¹/₈

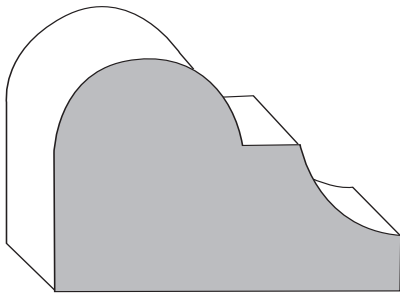

KE024
1¹/₄ x 1³/₄

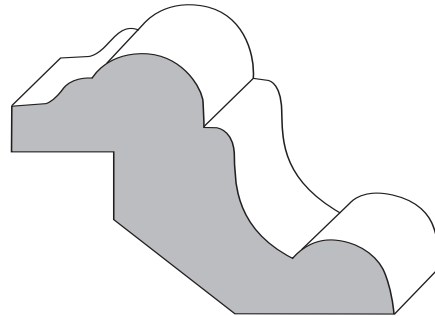

KE379-M
3/₄ x 2

KE379
3/₄ x 2¹/₈

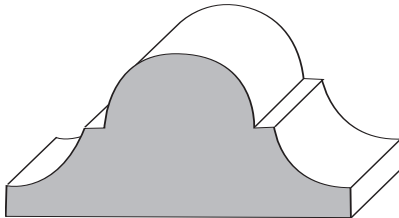

KE132-M
1¹/₁₆ x 1³/₄

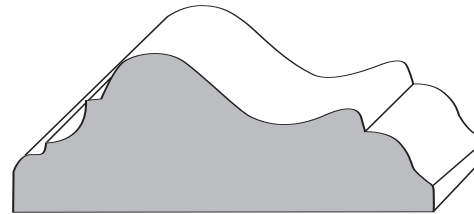

KE390
3/₄ x 2¹/₈

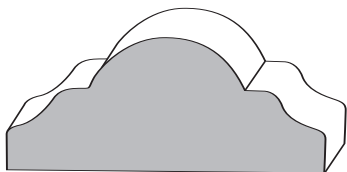

EL660-U
1¹/₁₆ x 1⁵/₈



DW134
TXDM8
1¹/₁₆ x 1¹/₂

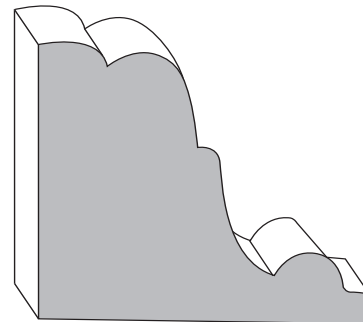

KE609
1⁷/₁₆ x 1³/₄



PANEL, COVE, HALF ROUND, S/4/S & MISCELLANEOUS

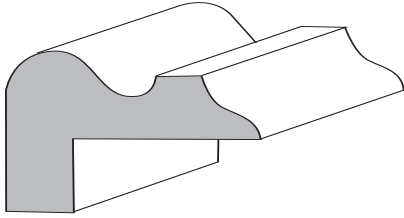

LCM11
 $\frac{7}{8} \times 1\frac{3}{8}$

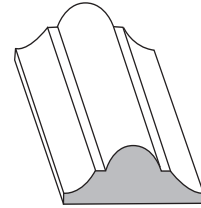

LHDM5
 $\frac{5}{16} \times \frac{3}{4}$

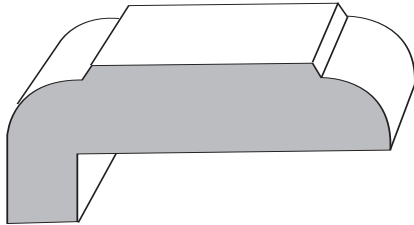

LCM12
 $\frac{13}{16} \times 2$

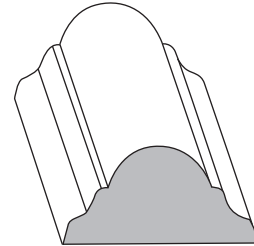

LHDM9
 $\frac{1}{2} \times 1$

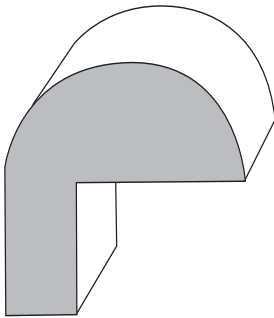

LHCMR
 $1\frac{1}{4} \times 1\frac{5}{16}$

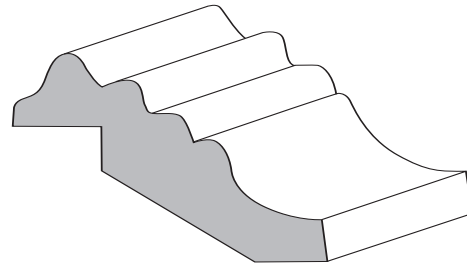

LHMPF
 $\frac{9}{16} \times 1\frac{3}{4}$

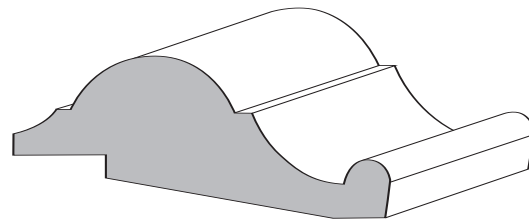

LPM10
 $\frac{11}{16} \times 2$

PANEL, COVE, HALF ROUND, S/4/S & MISCELLANEOUS

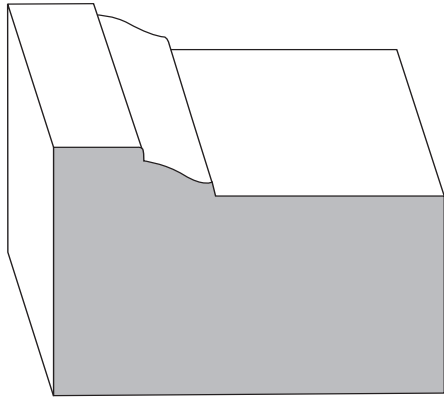

LS180
1 1/4 x 2

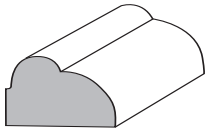

LSCM4
3/8 x 5/8

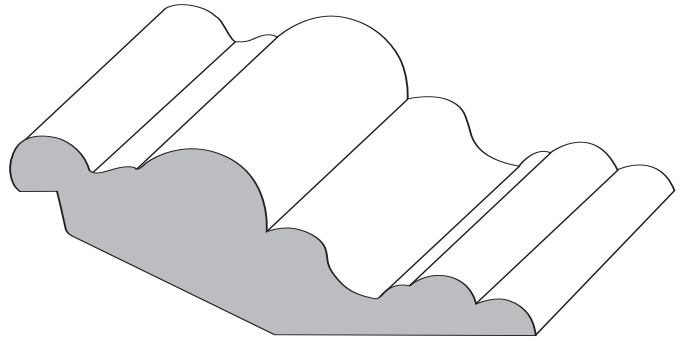

LSPM9
3/4 x 2 7/8

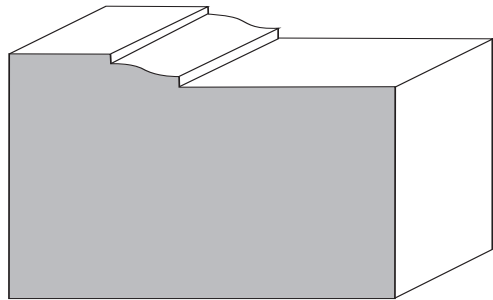

S5540
1 1/4 x 2

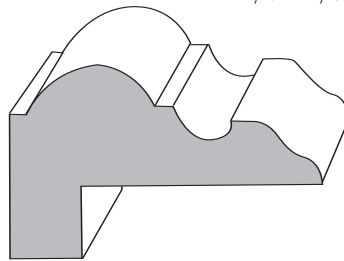

LSCM6
1 x 1 5/8

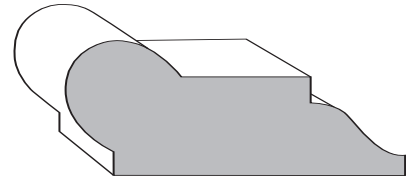

LS273
1 1/16 x 1 3/4

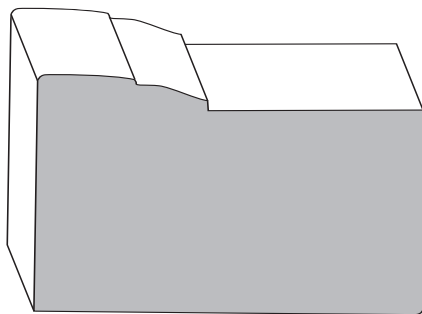

OR180
1 1/4 x 2

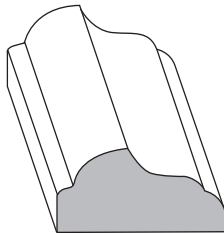

LSDM6
7/16 x 7/8

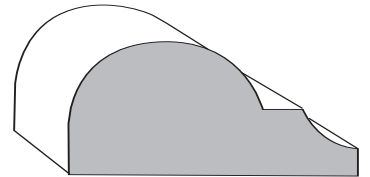

LSCM1
1 1/16 x 1 1/2

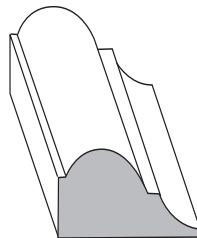

LSCM3
1/2 x 3/4

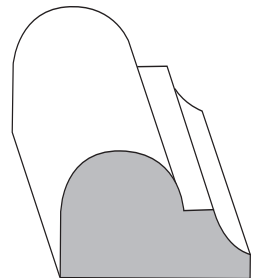

LSDM4
1 1/16 x 1

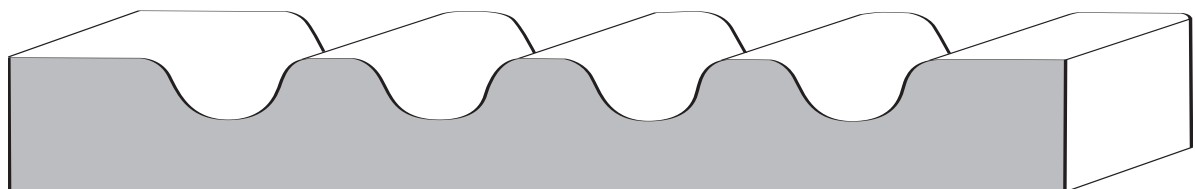

PIL01
1 3/16 x 4



PANEL, COVE, HALF ROUND, S/4/S & MISCELLANEOUS

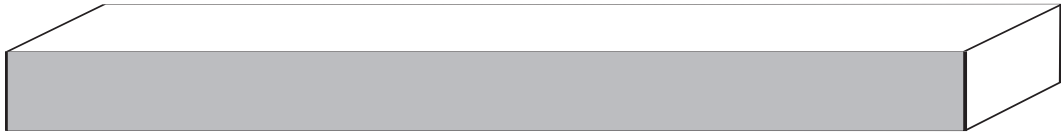

S1171
 $\frac{3}{8} \times 5$



S2212
 $\frac{9}{16} \times 3 \frac{1}{4}$

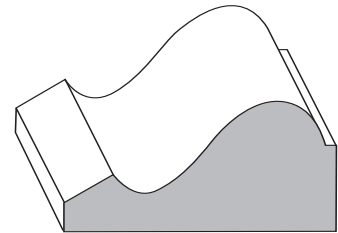

S5503
 $1 \frac{1}{16} \times 1 \frac{3}{8}$

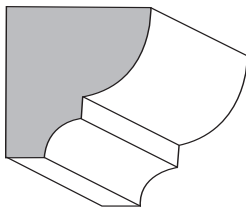

S3320
 $\frac{3}{4} \times \frac{3}{4}$

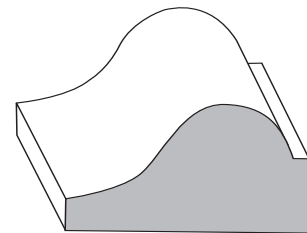

S5504
 $1 \frac{1}{16} \times 1 \frac{1}{4}$

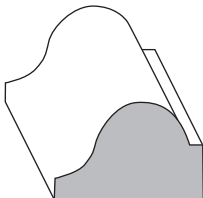

S5501
 $\frac{1}{2} \times \frac{3}{4}$

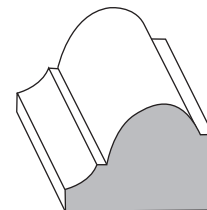

S5505
 $\frac{9}{16} \times \frac{3}{4}$

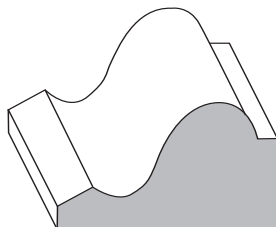

S5502
 $1 \frac{1}{16} \times 1 \frac{1}{8}$

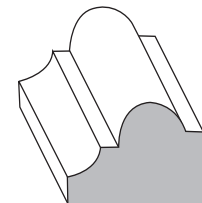

S5506
 $\frac{1}{2} \times \frac{11}{16}$



PANEL, COVE, HALF ROUND, S/4/S & MISCELLANEOUS

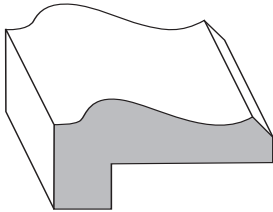

S5511
 $\frac{9}{16} \times 1 \frac{1}{8}$

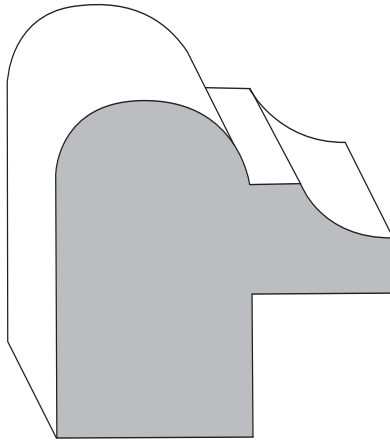

S5526
 $1 \frac{3}{4} \times 1 \frac{3}{4}$

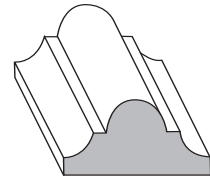

S5534
 $\frac{3}{8} \times \frac{3}{4}$

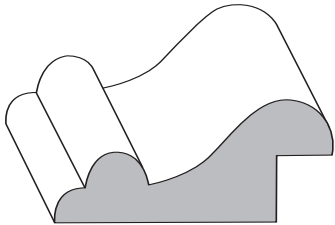

S5512
 $\frac{5}{8} \times 1 \frac{1}{2}$

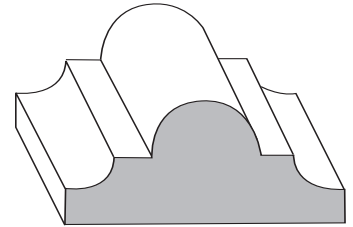

S5535
 $\frac{5}{8} \times 1 \frac{7}{16}$

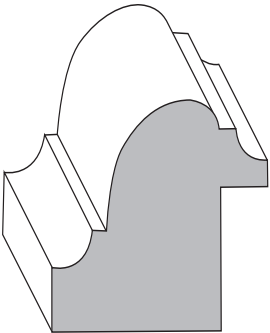

S5520
 $1 \frac{3}{16} \times 1 \frac{1}{8}$

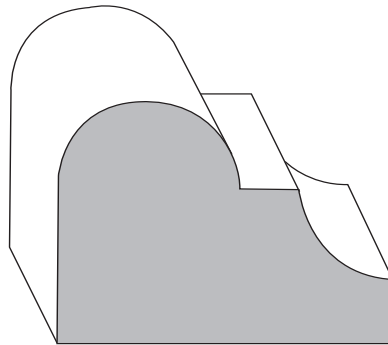

S5527
 $1 \frac{1}{4} \times 1 \frac{3}{4}$

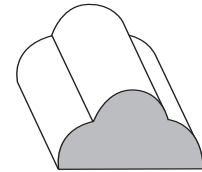

S5536
 $\frac{3}{8} \times \frac{3}{4}$

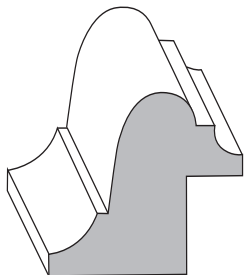

S5521
 $\frac{15}{16} \times 1$

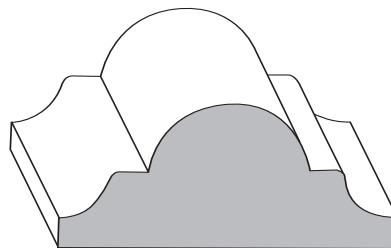

S5533
 $1 \frac{11}{16} \times 1 \frac{3}{4}$

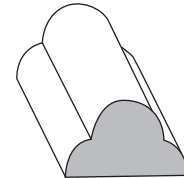

S5537
 $\frac{3}{8} \times \frac{5}{8}$



PANEL, COVE, HALF ROUND, S/4/S & MISCELLANEOUS

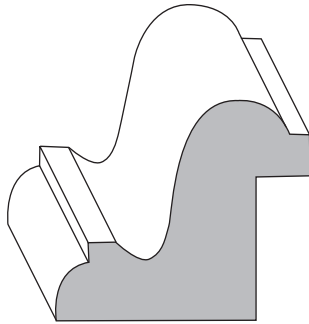

S5543
1 1/8 x 1 1/4

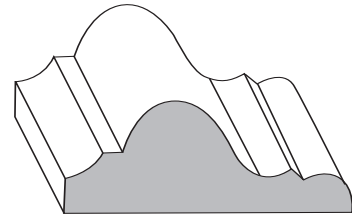

S5552
9/16 x 1 1/2

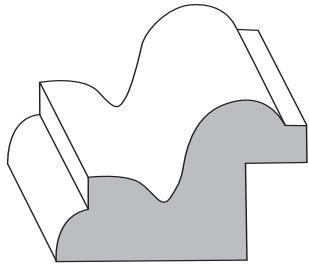

S5544
13/16 x 1 1/4

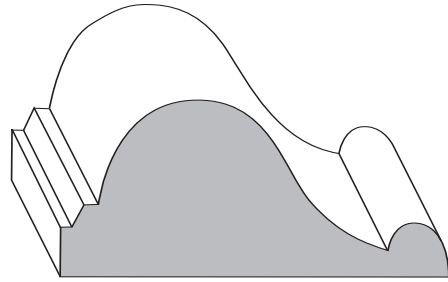

S5553
7/8 x 2

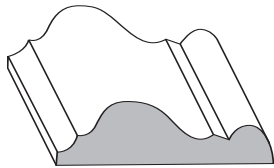

S5551
5/16 x 1 1/8

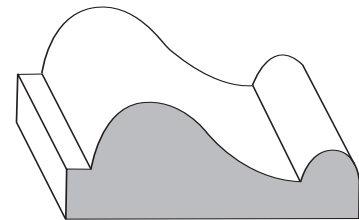

S5554
9/16 x 1 1/2

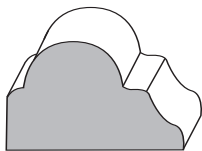

DW8132
9/16 x 7/8

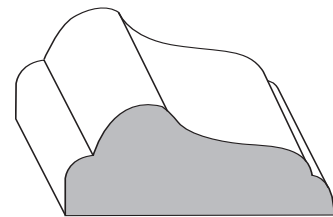

S5568
9/16 x 1 3/8

PANEL, COVE, HALF ROUND, S/4/S & MISCELLANEOUS

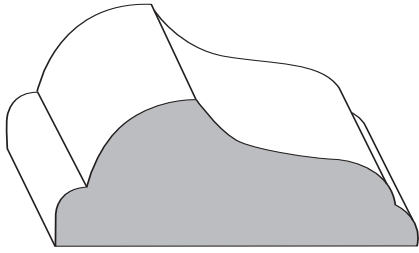

S5569
3/4 x 1 7/8

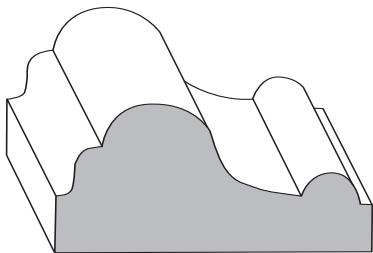

S5575
3/4 x 1 11/16

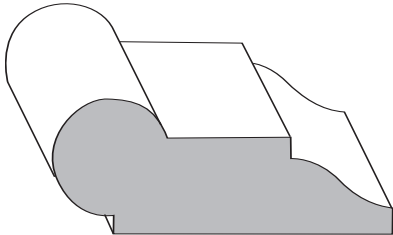

S5580
11/16 x 1 3/4

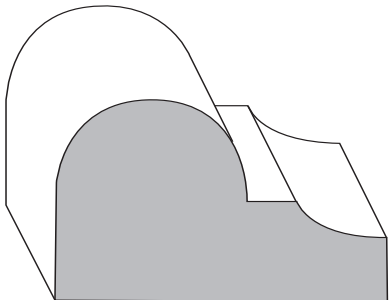

S5585
1 x 1 3/4

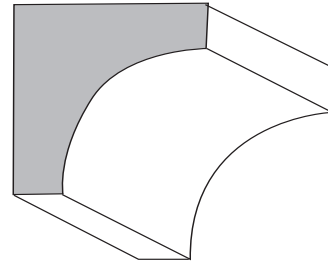

S6689
1 x 1

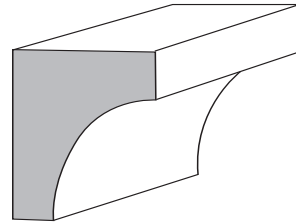

TX-92
3/4 x 7/8

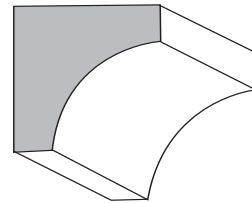

S6621
3/4 x 3/4

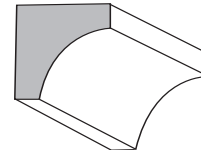

S6622
1/2 x 1/2

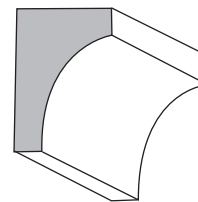

S6628
1/2 x 3/4

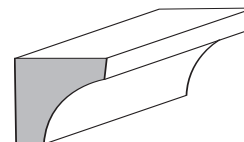

LS101
1/2 x 1/2



PANEL, COVE, HALF ROUND, S/4/S & MISCELLANEOUS

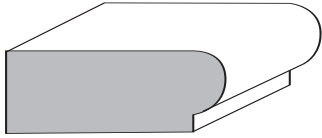

S6145
7/16 x 1 1/8

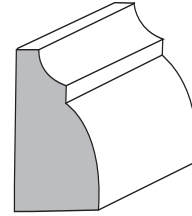

S6637
3/8 x 3/4

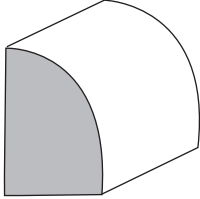

S6631
1/2 x 3/4

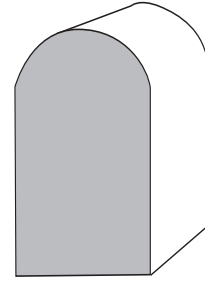

TXBB1
3/4 x 1 1/4

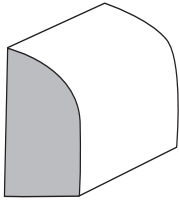

S6639
3/8 x 3/4

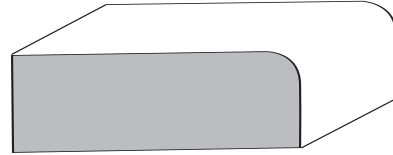

S6642
1/2 x 1 1/2

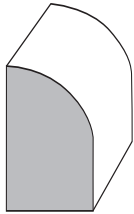

TX127 Smooth
LS127 Oak
7/16 x 3/4

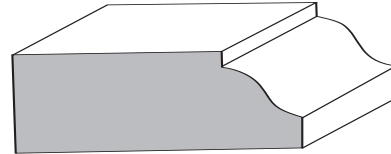

S6643
1/2 x 1 1/2

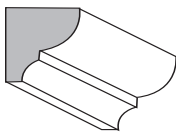

S6634
3/8 x 3/8

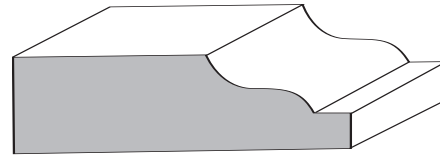

S6644
1/2 x 1 3/4

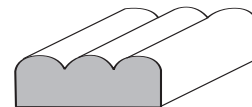

S6646
1/4 x 3/4



**PANEL, COVE, HALF ROUND,
S/4/S & MISCELLANEOUS**

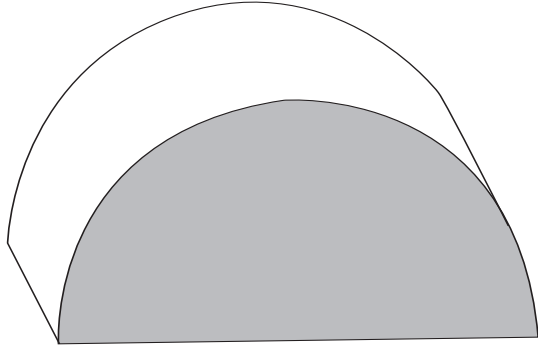

S6658
1 1/4 x 2 1/2

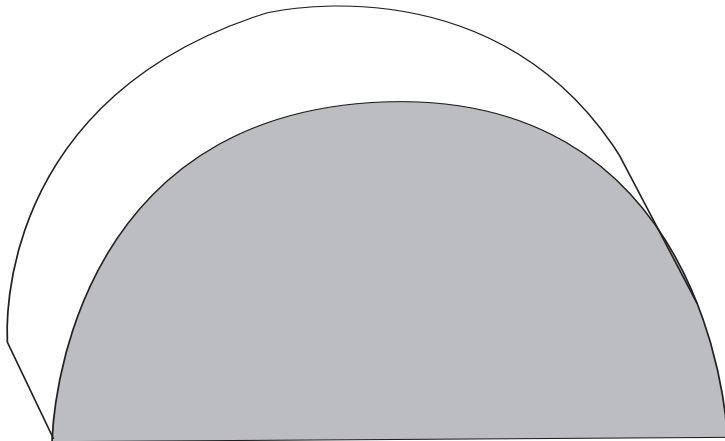

S6659
1 3/4 x 3 1/2

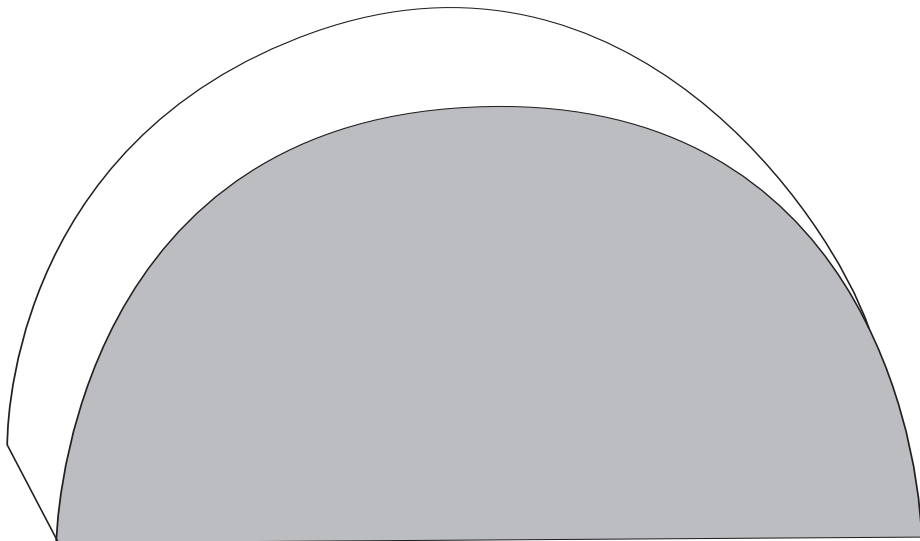

S6660
2 1/4 x 4 1/2



**PANEL, COVE, HALF ROUND,
S/4/S & MISCELLANEOUS**



S7701
1¹¹/₁₆ x 5 ⁷/₁₆

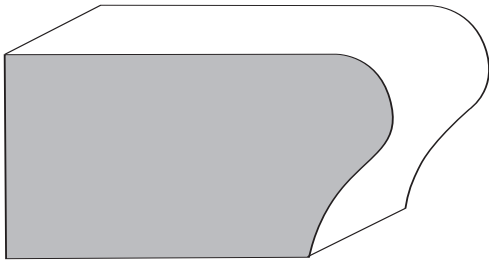

S7702
1 ¹/₁₆ x 2

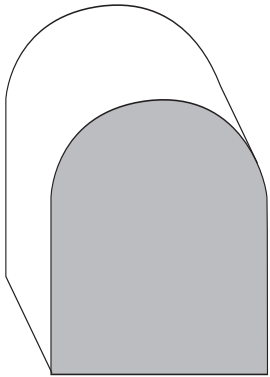

S7740
1 ¹/₈ x 1 ⁷/₁₆

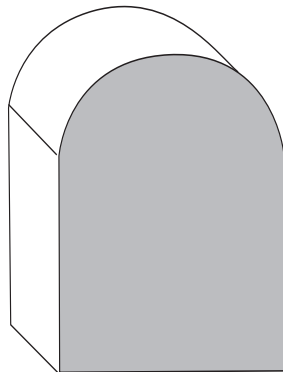

KE018
1 ¹/₈ x 1 ⁷/₁₆

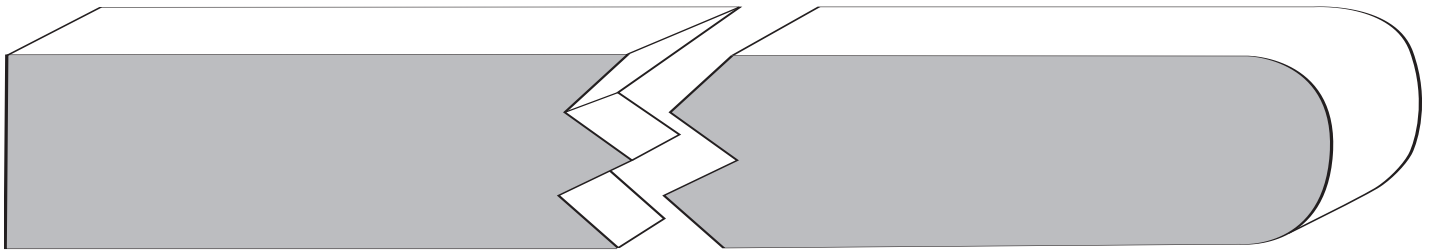

S7777
1 x 11 ¹/₄



PANEL, COVE, HALF ROUND, S/4/S & MISCELLANEOUS



S8605
 $\frac{3}{4} \times 7 \frac{1}{4}$



S8601
 $\frac{3}{4} \times 3 \frac{9}{16}$



S8822
 $1 \frac{3}{4} \times 1 \frac{3}{4}$
 S/4/S

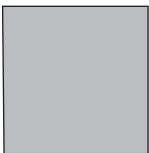

S8801
 1 x 1
 S/4/S

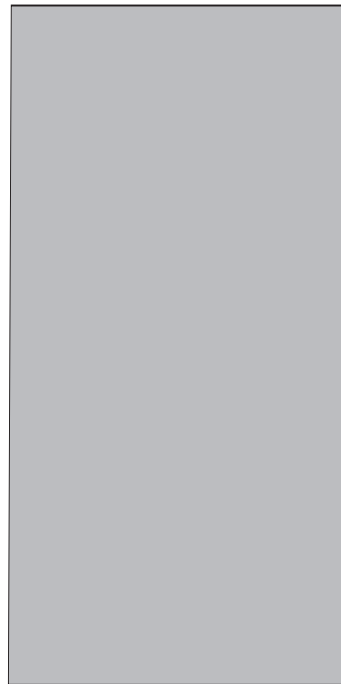

S8824
 $1 \frac{3}{4} \times 3 \frac{1}{2}$
 S/4/S



S8806
 $\frac{3}{4} \times 5 \frac{1}{2}$
 S/4/S



PANEL, COVE, HALF ROUND, S/4/S & MISCELLANEOUS

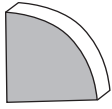

PM224
1/2 x 1/2

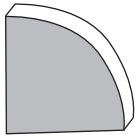

PM226
3/8 x 3/8

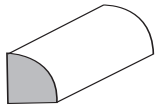

S6601
1/4 x 1/4

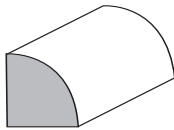

S6602
3/8 x 3/8

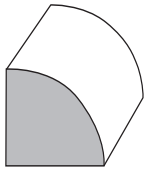

D8063
1/2 x 1/2

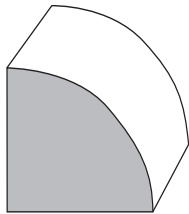

LS105
3/4 x 3/4

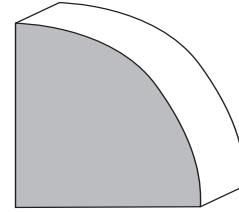

HO-53
1 x 1

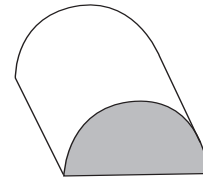

S6607
3/8 x 3/4

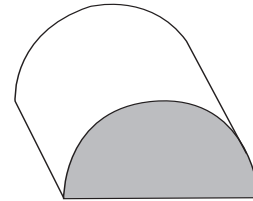

S6608
1/2 x 1

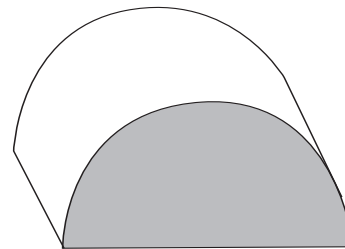

S6609
3/4 x 1 1/2

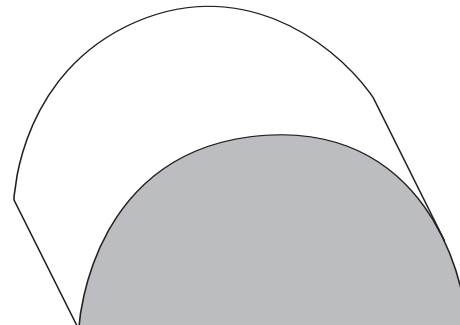

S6610
1 x 2



PANEL, COVE, HALF ROUND, S/4/S & MISCELLANEOUS

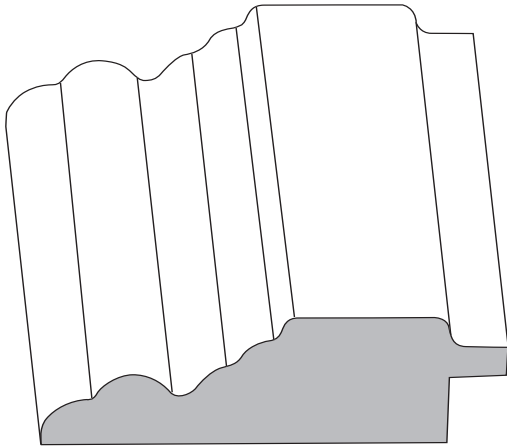

SK917
11/16 x 27/16

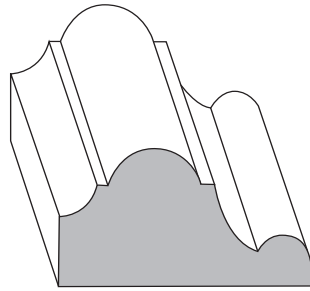

TXDM7
11/16 x 15/16

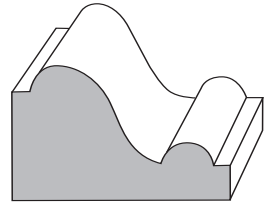

TXPM5
11/16 x 1 1/8

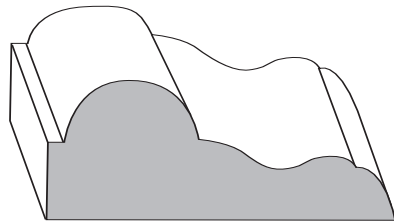

TDM22
3/4 x 1 3/4

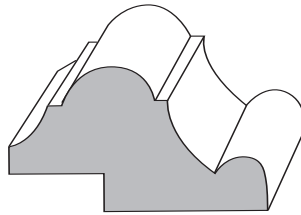

TXPM1
3/4 x 1 5/16

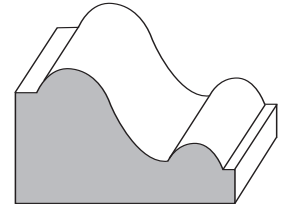

DWPM5
11/16 x 1 1/8

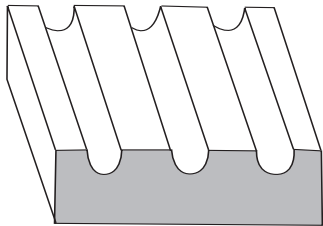

TXBS1
3/8 x 1 3/8

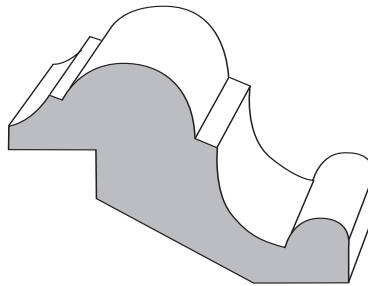

TXPM6
3/4 x 1 15/16

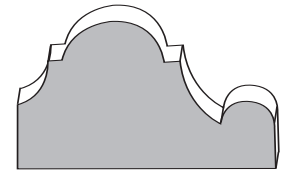

TXPM7
11/16 x 1 1/2

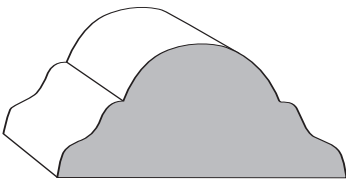

TXDM8
11/16 x 1 1/2

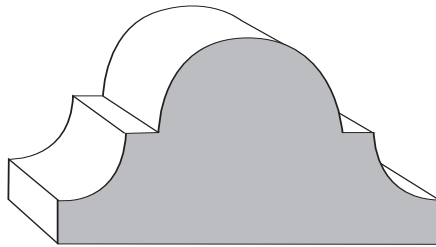

TXDM1
1 1/16 x 2

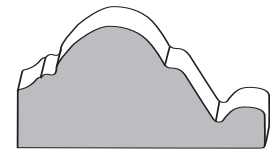

DWPM7-N
11/16 x 1 5/16

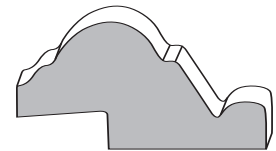

DWPM1
11/16 x 1 5/16

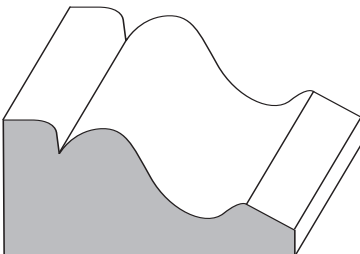

TXPM7
11/16 x 1 1/2

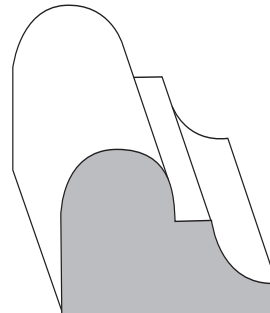

TXDM3
7/8 x 1 1/8

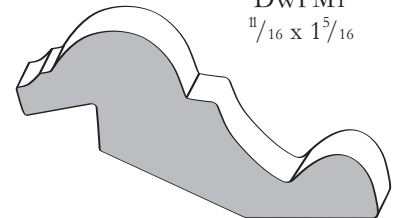

DWPM6
11/16 x 2



CHAIR RAIL

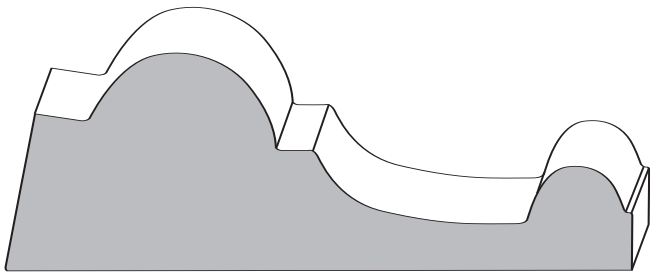

DWCR6
1¹/₄ x 3³/₄

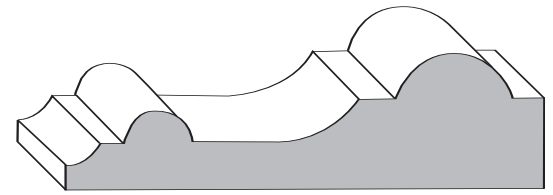

KE021
1¹/₁₆ x 2⁷/₁₆

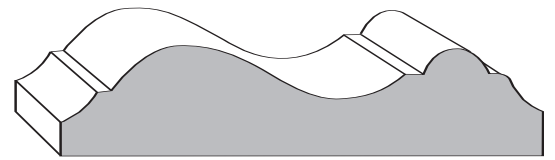

LSCR5
9⁹/₁₆ x 2¹/₂

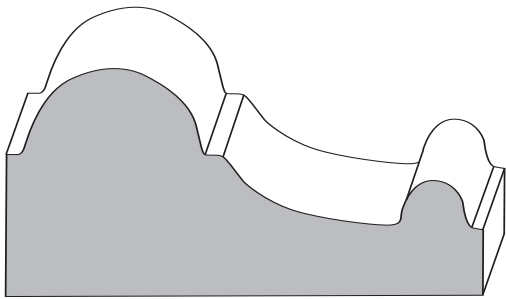

DWCR7
1³/₁₆ x 2¹/₂

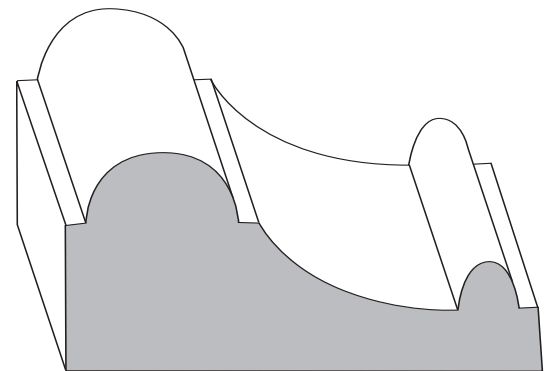

LSCR7
1¹/₈ x 2¹/₂

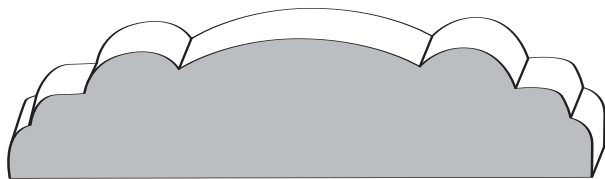

EL649-U
1¹/₁₆ x 3

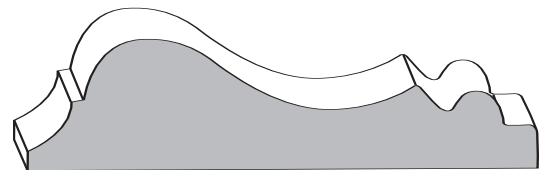

OR390-M
5⁵/₈ x 2⁵/₈

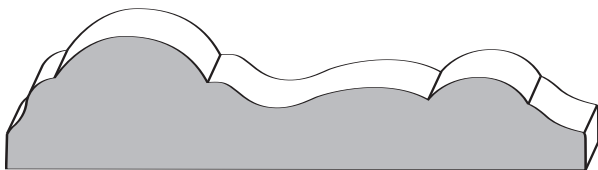

EL653-U
1¹/₁₆ x 3

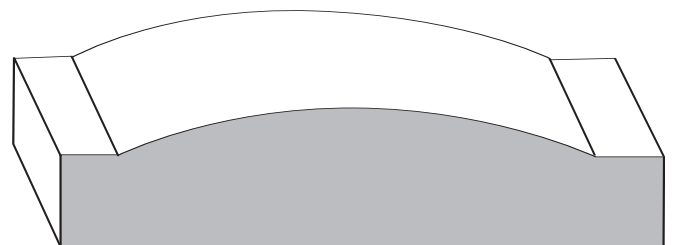

S1172
1¹/₁₆ x 3¹/₈

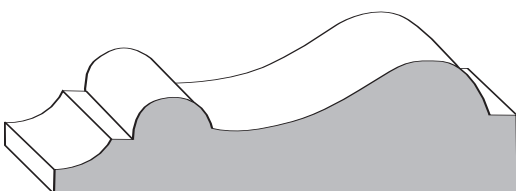

KE020
1¹/₁₆ x 2³/₈

CHAIR RAIL

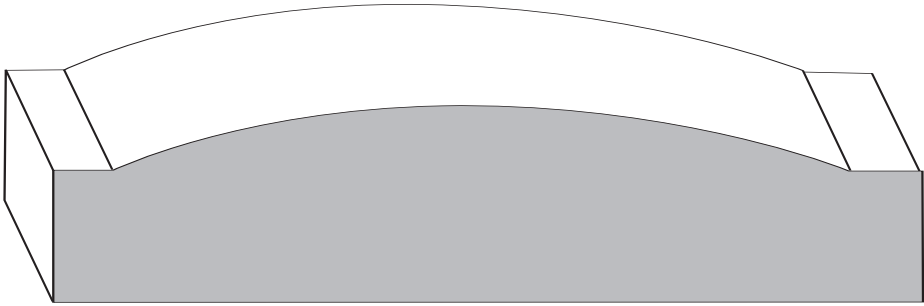

S1173
 $1 \frac{1}{16} \times 4 \frac{1}{2}$

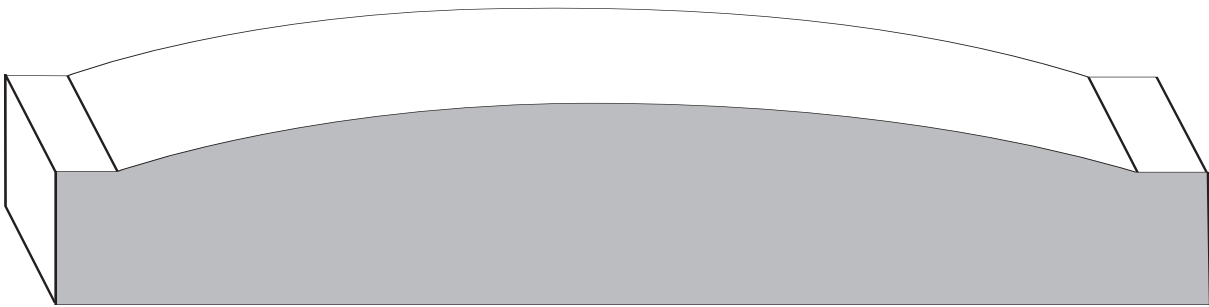

S1174
 $1 \frac{7}{16} \times 6$

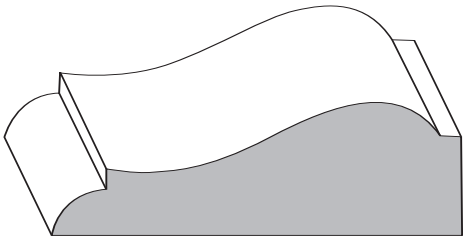

S2510
 $1 \frac{1}{16} \times 2 \frac{1}{8}$

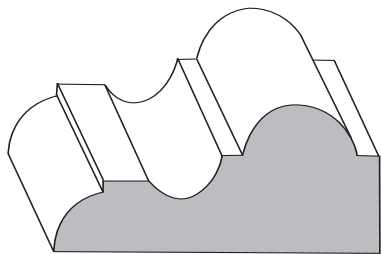

S5563
 $\frac{3}{4} \times 1 \frac{11}{16}$



CHAIR RAIL

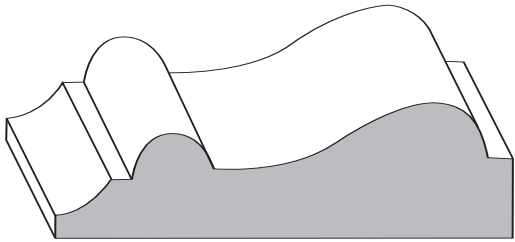

S2566
 $1\frac{1}{16} \times 2\frac{3}{8}$

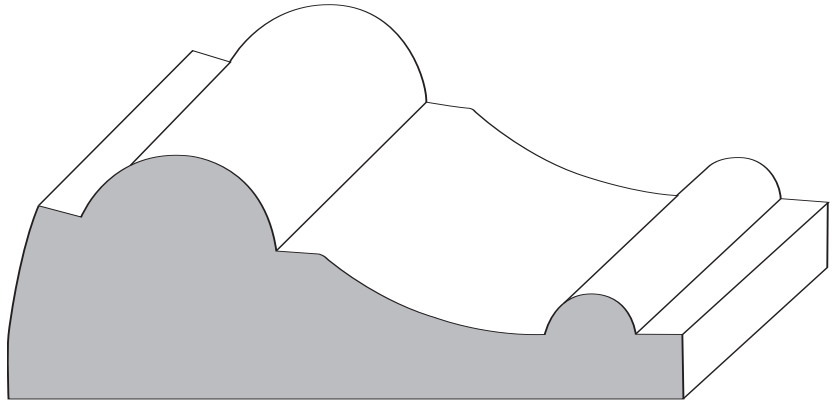

TXCR6
 $1\frac{1}{4} \times 3\frac{1}{2}$

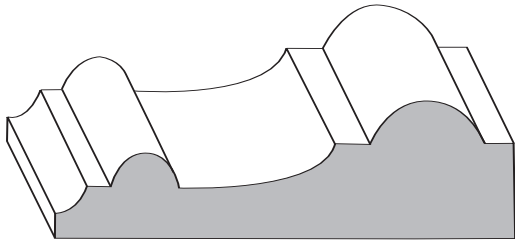

S2567
 $1\frac{1}{16} \times 2\frac{3}{8}$

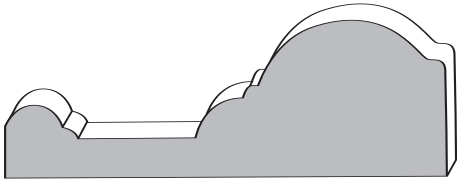

TPM14-Oak
 $\frac{5}{16} \times 2\frac{1}{4}$

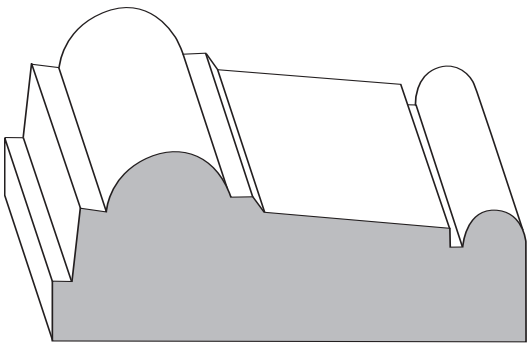

TXCR2
 $1 \times 2\frac{1}{2}$

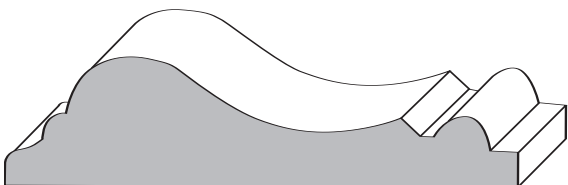

KE382-M
 $1\frac{1}{16} \times 2\frac{5}{8}$



GENERAL CONDITIONS

Returns

Custom profiles and special orders cannot be returned. Standard profiles must be in new resaleable condition, returned prepaid and subject to prior approval and a 25% restocking charge.

Terms

All sales will be C.O.D. unless prior credit arrangements have been made.

Prices

All prices can be subject to change without notice.

Claims

Claims for breakage or damage must be made with transportation carrier within five days from receipt of merchandise.

Warranties

All product to be free from defects in material and workmanship for a period of one year from date of purchase. Although due to the variable conditions under which these goods may have been stored, handled, or installed we reserve the right to amend or exclude said warranty. Defective material will be replaced at no charge to the customer or refund the purchase price.

COLLECTION

If we refer this invoice to our attorneys for collection or enforcement, Purchaser agrees to pay all such attorney's fees, expenses and court costs, without regard to whether a lawsuit is filled, including those incurred in trial, on appeal and in preparation therefore.



RESINART Corp.
Flexible Mouldings
1621 Placentia Avenue
Costa Mesa, CA 92627

www.resinartwest.com

Voice:
Toll Free: 1.800.258.8820
949.642.3665
Fax:
949.642.6519

Hours of Operation
Monday-Friday:
7:00-3:30 pst